



**Naziv projekta:**

**“Izrada i uspostavljanje  
okvira interoperabilnosti i standarda za razmjenu podataka”**

**Inicijalni rječnik podataka**

**Projekt implementira:**

**Infodom d.o.o.**



**Projekt financira:**

**Fond za reformu javne uprave u BiH**

	<p style="text-align: center;">PROJEKT IZRADA I USPOSTAVLJANJE OKVIRA INTEROPERABILNOSTI I STANDARDA ZA RAZMJENU PODATAKA <b>INICIJALNI RJEČNIK PODATAKA</b></p>	Oznaka: PARCO-IFBIH
		Page: 2 of 124

Historija izmjena:

Datum	Verzija	Opis
29.02.2012	1.0	Inicijalna verzija
10.08.2012	1.1	Usklađeno sa Isporukom K 4.2 Strateškim prijedlozima za optimalnu mobilizaciju i međusobno povezivanje elektronskih registara
9.10.2012	1.2	Dopuna jezgrenih komponenti prema K4.2

## Sadržaj

1.	UVOD.....	4
1.1	OBIM dokumenta (SCOPE).....	4
1.2	Namjena i korištenje dokumenta .....	5
1.3	Povezani dokumenti .....	5
1.4	Definicije pojmova i skraćenica.....	6
2.	Metodologija izrade inicijalnog rječnika podataka .....	9
2.1	Lista meta-rječnika u inicijalnom rječniku podataka .....	9
2.2	Način korištenja rječnika podataka .....	11
3.	Poslovni dokumenti i poruke.....	13
3.1	Zahtjev za izdavanje Jedinog matičnog broja.....	13
3.2	Zahtjev za izdavanje Lične karte .....	13
3.3	Zahtjev za izdavanje vozačke dozvole.....	14
3.4	Zahtjev za registraciju vozila .....	14
3.5	Izvod iz Matične Knjige rođenih .....	14
3.6	Izvod iz Matične Knjige vjenčanih.....	15
3.7	Izvod iz Matične Knjige umrlih .....	15
3.8	Uvjerenje o državljanstvu .....	15
3.9	Zahtjev za upis u sud. registar – pravna lica.....	16
3.10	Izvod iz sudskog registra .....	16
3.11	Pasoš.....	17
3.12	Izvod iz evidencije JMB .....	17
3.13	Izvod iz evidencije LK.....	18
3.14	izvod iz evidencije vozačkih dozvola .....	18
3.15	Izvod iz evidencije prebivališta/boravišta .....	18
3.16	Izvod iz evidencije vozila .....	19
3.17	Potvrda o plaćenim porezima i doprinosima .....	19
3.18	Zdravstveno osiguranje prijava/odjava .....	19
3.19	Penziono osiguranje prijava/odjava .....	20
3.20	Nalog za plaćanje.....	20
3.21	Generički dokument .....	21
3.22	Generička ovojnica poruke .....	21
3.23	Izvod iz registra prostornih jedinica .....	21
3.24	Izvod iz adresne evidencije .....	22
3.25	Klasifikacija .....	22
4.	Poslovni informacijski entiteti.....	23
5.	Dokumenti XML.....	108
6.	Popis priloga .....	123



## 1. UVOD

### 1.1 OBIM DOKUMENTA (SCOPE)

Ovaj dokument sastavljen je u sklopu projekta „Izrada i uspostavljanje okvira interoperabilnosti i standarda za razmjenu podataka“ i predstavlja sastavni dio Komponente 2 „Stvaranje zajedničkih otvorenih standarda za razmjenu podataka i definicija meta-podataka“ koja se sastoji od sljedećih isporuka

1. Lista meta-rječnika podataka, te definicija XML shema/standarda koji ih opisuju
2. Standardi, vodilje i politike za razvoj i održavanje rječnika podataka
3. Inicijalni rječnik podataka u formi XML shema, koji se treba objaviti kao otvoreni standard
4. Nacrt Uputstva za primjenu zajedničkih otvorenih standarda za razmjenu podataka i definicije meta-podataka

Dokument je namijenjen Implementacionom timu i Nadzornom timu Projekta kao prijedlog otvorenog standarda za razmjenu podataka unutar državne uprave, a služi kao dio platforme za izradu nacionalnog Okvira interoperabilnosti.

Dokument se zasniva se na Evropskom okviru interoperabilnosti, prethodno urađenoj analizi najboljih praksi u isporuci 1. Lista meta-rječnika podataka (poglavlje „Pregled relevantnih projekata u EU i svijetu“), UN/CEFACT standardima i metodologiji za definiciju jezgrenih komponenti (Core Components) te UN/CEFACT biblioteci jezgrenih komponenti (Core Components Library).

U dokumentu i priložima sadržan je inicijalni rječnik podataka u formi UML modela, Excel tablica sa definicijama i nazivima pojmova u inicijalnom rječniku te pripadajućih XML shema.

U poglavlju 2. opisani su metodologija izrade i korištenja inicijalnog rječnika podataka i definiranih meta-rječnika.

U poglavlju 3. prikazani su modeli najznačajnijih poslovnih dokumenata i poruka koji su modelirani u sklopu projekta, a zasnovani su na Strategiji reforme javne uprave BIH i pripadnom akcionom planu te strategijama razvoja relevantnih državnih organa kao što su IDDEEA i AID.

U poglavlju 4. definisani su modeli Poslovnih Informacionih entiteta koji su modelirani za potrebe izgradnje nacionalne biblioteke jezgrenih komponenti. Biblioteka se zasniva na i uključuje inačicu D.11A UN/CEFACT biblioteke jezgrenih komponenti (Core Components Library) objavljenu 22. 6. 2011. godine, zadnju verziju dostupnu u vrijeme izrade projekta.

Sastavni dio dokumenta su i prilozi koji sadrže tehničke specifikacije definiranog modela, i to podatkovni model prikazan u obliku Excel datoteke, XSD shema razvijene nacionalne biblioteke i XML dokumenata/poruka modeliranih u sklopu projekta te pripadajuće tehničke dokumentacije.

	PROJEKT IZRADA I USPOSTAVLJANJE OKVIRA INTEROPERABILNOSTI I STANDARDA ZA RAZMJENU PODATAKA <b>INICIJALNI RJEČNIK PODATAKA</b>	Oznaka: PARCO-IFBIH
		Page: 5 of 124

## 1.2 NAMJENA I KORIŠTENJE DOKUMENTA

Dokument služi kao prijedlog otvorenog standarda za razmjenu podataka unutar državne uprave, te između državne uprave i korisnika njenih usluga.

Definiše strukturu podataka (poruka) za najznačajnije poslovne dokumente, te nacionalnu biblioteku jezgrenih komponenti koja omogućava jednostavno modeliranje preostalih poslovnih dokumenata za čijom se razmjenom pokaže potreba tokom implementacije specifičnih informatičkih rješenja.

Pri tome je svaki vlasnik podataka (organ državne uprave, agencija itd) odgovoran za modeliranje i održavanje shema za razmjenu podataka (poruka i dokumenata) koji su u njegovoj nadležnosti, dok se interoperabilnost obezbjeđuje tako da se za modeliranje poslovnih dokumenata i poruka koriste isključivo komponente iz zajedničke nacionalne biblioteke jezgrenih komponenti.

Učesnici kojima je dokument namijenjen su, zavisno od aktivnosti koje se provode: analitičari poslovnih procesa, specijalisti za dizajn sistema i developeri, voditelji projekata, te ostala nadležna lica za dizajn i implementaciju sistema koji se implementuje/prilagođuje prema standardima interoperabilnosti.

## 1.3 POVEZANI DOKUMENTI

U skladu s Početnim izvještajem izlazne podatke po ostalim komponentama čini sljedeća dokumentacija:

Komponenta 1. Razvijanje okvira interoperabilnosti za BiH, a koja uključuje:

1. Najbolje prakse, iskustva i trendove interoperabilnosti u BiH i drugim zemljama.
2. Vodilje okvira interoperabilnosti koji sadrže koncept, pravila i standarde.
3. Nacrt Odluke o usvajanju Okvira interoperabilnosti za BiH s pratećim setom dokumenata
4. Nacrt Okvira interoperabilnosti za BiH

Komponenta 3. Razvijanje standarda za arhitekturu sistema i razvoj aplikacija:

1. Vodilje i standardi za arhitekturu sistema i razvoj aplikacija
2. Nacrt Uputstva za primjenu standarda za arhitekturu sistema i razvoj aplikacija

Komponenta 4. . Razvijanje strategije javnih registara

1. Analiza postojećih parcijalnih elektronskih registara
2. Strateški prijedlozi za optimalnu mobilizaciju i međusobno povezivanje elektronskih registara
3. Lista prioriteta za implementaciju javnih registara
4. Nacrt Strategije javnih registara u BiH
5. Nacrt Uputstva za implementaciju Strategije javnih registara



## 1.4 DEFINICIJE POJMOVA I SKRAĆENICA

Pojam	Definicija	
ABIE	Aggregate Business Information Entity	
ACC	Aggregation Core Component	
ASBIE	Association Business Information Entity	
BBIE	Basic Business Information Entity	
BCC	Basic Core Component	
BDT	Business Data Type	
BIE	Basic Information Entity	
CC	Core Components	
CCL	Core Components Library	Biblioteka jezgrenih komponenti
CCT	Core Component Type	
CCTS	Core Components Technical Specification	
CEN	Comite Européen de Normalisation	
CEN CWA	CEN Workshop Agreement	
CEN/ISSS	Comite Européen de Normalisation/Information Society Standardisation System	
CENELEC	European Committee for Electro technical Standardization	
DEN	Dictionary Entry Name	
ebCCTS	ebXML Core Components Technical Specification	



PROJEKT  
IZRADA I USPOSTAVLJANJE OKVIRA INTEROPERABILNOSTI I  
STANDARDA ZA RAZMJENU PODATAKA  
INICIJALNI RJEČNIK PODATAKA

Oznaka:  
PARCO-IFBIH

Page: 7 of 124

Pojam	Definicija	
ebCPP	ebXML Collaboration Protocol Profile and Agreement	
ebMS	ebXML Messaging Services	
ebRIM	ebXML Registry Information Model	
ebXML	electronic business XML	
EDI	Electronic Data Interchange	
EDIAKT	Austrijski standard za komunikaciju bez upotrebe papira	
EDIFACT	EDI for Administration, Commerce and Transport	
eGIF	eGovernment Interoperability Framework	
ISO	International Organisation for Standardization	
ISO/IEC	International Organisation for Standardization/International Electrotechnical Commission	
MIG	Message Implementation Guide	
NDR	Naming and Design Rules	Pravila dizajna i imenovanja
OIO	Offentlig Information Online	
OIOXML	Offentlig Information Online XML	Danski nacionalni XML standard
SAGA	Standards and Architectures for e-Government Applicatios	Preporuka njemačke vlade – <i>Definicija tehničkih standarda i arhitektura u e-Government aplikacijama kao i</i>



PROJEKT  
IZRADA I USPOSTAVLJANJE OKVIRA INTEROPERABILNOSTI I  
STANDARDA ZA RAZMJENU PODATAKA  
INICIJALNI RJEČNIK PODATAKA

Oznaka:  
PARCO-IFBIH

Page: 8 of 124

Pojam	Definicija	
		<i>standardizacija procesa i podataka u državnoj upravi</i>
SEMIC.EU		
UBL	Universal Business Language	
UML	Unified Modelling Language	
UMM	UN/CEFACT's Modelling Methodology	
UN/CEFACT	UN Centre for Trade Facilitation and Electronic Business	
XSD	XML Schema Definition	



## 2. METODOLOGIJA IZRADA INICIJALNOG RJEČNIKA PODATAKA

Inicijalni rječnik podataka formiran je prema UN/CEFACT CCL biblioteci. Nad CCL bibliotekom jezgrenih komponenti napravljena je selekcija i potrebna odgovarajuća modifikacija komponenti prema specifičnim potrebama državne uprave BiH.

Kod primjene ove metodologije razdvojena je sintaksa od semantike podataka, što omogućava fleksibilan rad i održavanje sistema koji se na nju oslanjaju. Takođe, omogućeno je značajno ubrzavanje izrade početnog rječnika podataka, te međunarodna semantička kompatibilnost.

Primjenjena metodologija koristi pregledan način modeliranja podataka, koristi široko dostupne alate, te obezbjeđuje lagano i pouzdano povezivanje uz očuvanje konzistentnosti poslovnog i tehničkog sloja (UML, Excel, alati za modeliranje prema UN/CEFACT).

Primjenjena je UN/CEFACT biblioteka jezgrenih komponenti (CCL) trenutno u verziji 11A.

### 2.1 LISTA META-RJEČNIKA U INICIJALNOM RJEČNIKU PODATAKA

Lista meta-rječnika u inicijalnom rječniku podataka zasnovana je na Strategiji reforme javne uprave BiH i pripadnom akcionom planu te strategijama razvoja relevantnih državnih organa kao što su IDDEEA i AID i sadrži najznačajnije poruke i poslovne dokumente čija je implementacija predviđena tim strateškim dokumentima.

Lista meta-rječnika sadrži XML sheme sljedećih poruka / poslovnih dokumenata.

Poruka	Domena / Kontekst	Podatkovni objekt
Zahtjev za izdavanje jedinstvenog matičnog broja	Stanovništvo	2 p
Zahtjev za izdavanje lične karte	Stanovništvo	2 r
Zahtjev za izdavanje vozačke dozvole	Stanovništvo	2 e
Zahtjev za registraciju vozila	Stanovništvo	2 d
Izvod iz Matične knjige rođenih (rodni list)	Stanovništvo	2 a
Izvod iz Matične knjige vjenčanih (vjenčani list)	Stanovništvo	2 a
Izvod iz Matične knjige umrlih (smrtovnica)	Stanovništvo	2 a
Uvjerenje o državljanstvu	Stanovništvo	2 b



<b>Poruka</b>	<b>Domena / Kontekst</b>	<b>Podatkovni objekt</b>
Zahtjev za upis u sud. registar – pravna lica	Privreda /Organizacije	3 a
Izvod iz sudskog registra	Organizacije	3 a
Pasoš	Stanovništvo	2 f
Izvod iz evidencije JMB	Stanovništvo	2 p
Izvod iz evidencije ličnih karata	Stanovništvo	2 r
Izvod iz evidencije vozačkih dozvola	Stanovništvo	2 e
Izvod iz evidencije prebivališta/boravišta	Stanovništvo	2 c
Izvod iz evidencije vozila	Stanovništvo	2 d
Potvrda o plaćenim porezima i doprinosima	Financije	4 d
Zdravstveno osiguranje prijava/odjava	Privreda / Organizacije	2 o
Penziono osiguranje prijava/odjava	Privreda / Organizacije	2 n
Nalog za plaćanje	Financije	2
Generički dokument	Generički dokumenti	5
Generička ovojnica poruke	Generički dokumenti	5
Izvod iz registra prostornih jedinica	Prostor	1 b
Izvod iz adresne evidencije	Prostor	1 b
Klasifikacija	Statistika i pokazatelji	6 b



## 2.2 NAČIN KORIŠTENJA RJEČNIKA PODATAKA

Odabrane su odgovarajuće komponente UN/CEFACT CCL biblioteke koje će se koristiti u okviru rječnika.

Prema selektiranim CC komponentama napravljena je konfiguracija BIE komponenti, a za potrebe definicije podatkovnog modela odabranih formulara/podataka.

Način rada s rječnikom podataka opisan je u dokumentu isporuci K.2.2 „Standardi za razvoj i održavanje rječnika“.

Osnovni koraci koji se prema tome koriste su:

- modeliranje poslovnih procesa
- modeliranje poslovnih dokumenata
- modeliranje XML shema
- ažuriranje repozitorija – repozitorij za:
  - jezgrene komponente/podatke
  - XML dokumente/scheme
  - Web servisi
  - Modeli poslovnih procesa
- portal – publiciranje dokumentacije na portalu

Prvi korak je snimka poslovnih procesa. Nakon toga se pristupa modeliranju potrebnih funkcionalnosti sistema preko kojih se ti procesi obavljaju, te podataka koji se razmjenju, kao dokumenata u kojima su ti podaci sadržani. Prema ovom podatkovnom modelu odabiru se odgovarajuće CC i na bazi njih se radi prilagođeni podatkovni model na bazi koga se formiraju XML sheme.

Koraci koji se provode prilikom otkrivanju i dizajna dokumenata su:

1. Pretraživanje repozitorija *Poslovnih procesa* radi pronalaska procesa koji odgovara zahtjevima
  - a. Modeliranje novog *Poslovnog procesa* ako već ne postoji prema UNC/CEFACT metodologiji za modeliranje i registracija
  - b. Detaljna analiza zahtjeva za poslovne informacije prema koracima za CC Discovery
2. Identifikacija odgovarajućih *Kontekstnih kategorija* za selektovane *Poslovne procese*
  - a. *Kontekst Poslovnih procesa*
  - b. *Geopolitički kontekst*
3. Registracija ponovnog korištenja selektovanih Poslovnih procesa u skupu Konteksta u kojima se ti procesi koriste
4. Pregled raspoloživih Entiteta poslovnih informacija (BIE) i selekcija odgovarajućeg podskupa koji je u skladu s zahtjevom na Poslovni proces koji se razvija
  - a. Ako ne postoji BIE koji za određeni Poslovni proces ne zadovoljava sve zahtjeve za podacima, potrebno je pretražiti registar svih BIE kako bi se provjerilo da li odgovarajući BIE postoji

	PROJEKT IZRADA I USPOSTAVLJANJE OKVIRA INTEROPERABILNOSTI I STANDARDA ZA RAZMJENU PODATAKA <b>INICIJALNI RJEČNIK PODATAKA</b>	Oznaka: PARCO-IFBIH
		Page: 12 of 124

- b. Ako svi zahtijevani BIE postoje potrebno je pregledati MIG, XML sheme i druge sintaksno specifične opise poruka i odabrati one koje odgovaraju zahtjevima za tehničku implementaciju i rješenje
5. Kreiranje MIG, XML shema i dr.

Nakon završetka modeliranja podataka generišu se XML sheme (u XSD formatu) koje se koriste u konkretnim implementacijama interoperabilnih sistema.

### 3. POSLOVNI DOKUMENTI I PORUKE

#### 3.1 ZAHTJEV ZA IZDAVANJE JEDINSTVENOG MATIČNOG BROJA

Zahtjev za izdavanje jedinstvenog matičnog broja.

##### ABIE **JMB Request**

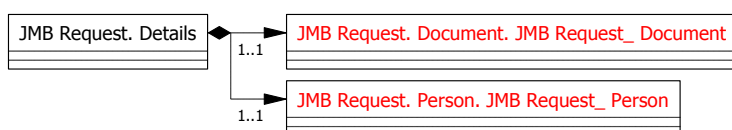

#### 3.2 ZAHTJEV ZA IZDAVANJE LIČNE KARTE

Zahtjev za izdavanje lične karte.

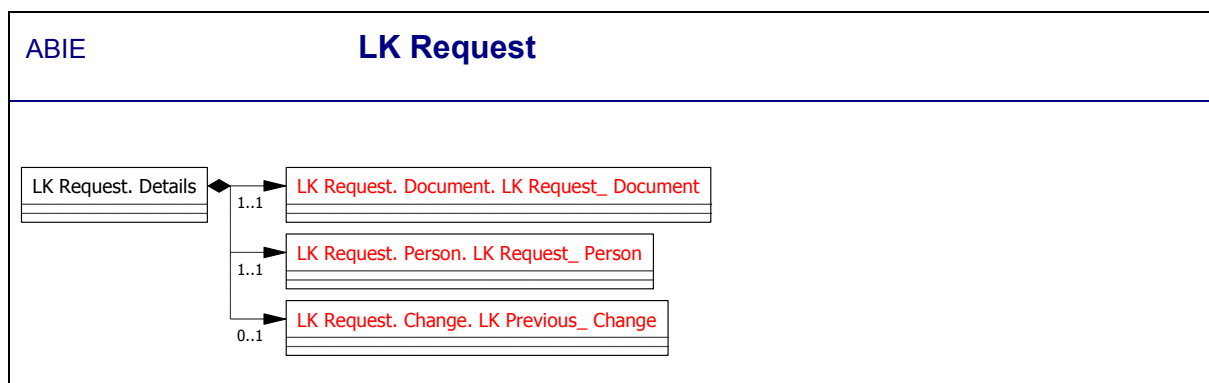

### 3.3 ZAHTJEV ZA IZDAVANJE VOZAČKE DOZVOLE

Zahtjev za izdavanje vozačke dozvole.

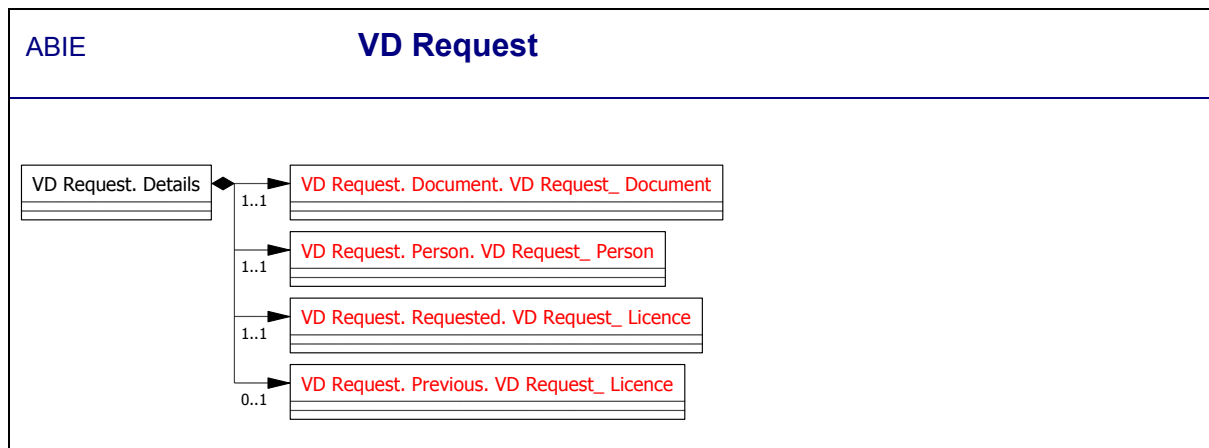

### 3.4 ZAHTJEV ZA REGISTRACIJU VOZILA

Zahtjev za registraciju vozila.

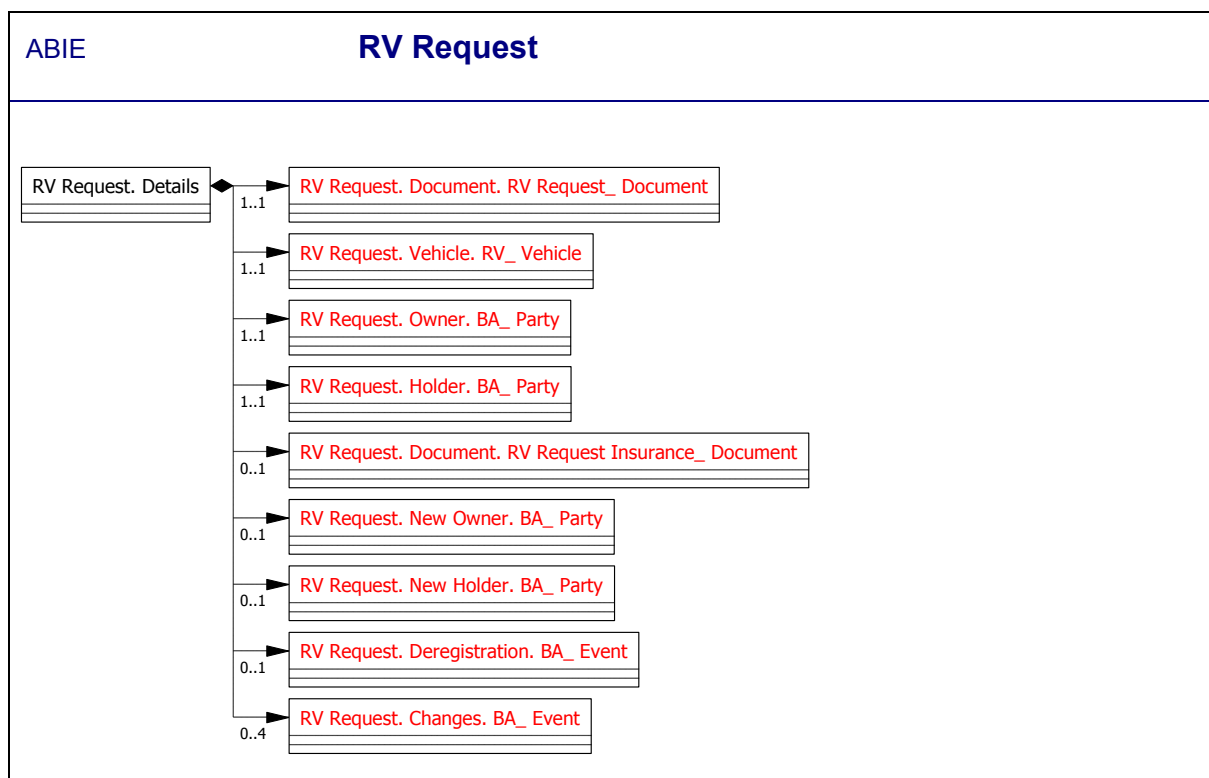

### 3.5 IZVOD IZ MATIČNE KNJIGE ROĐENIH

Izvod iz Matične knjige rođenih.

ABIE

### MKR Excerpt Birth



## 3.6 IZVOD IZ MATIČNE KNJIGE VJENČANIH

Izvod iz Matične knjige vjenčanih.

ABIE

### MKR Excerpt Marriage

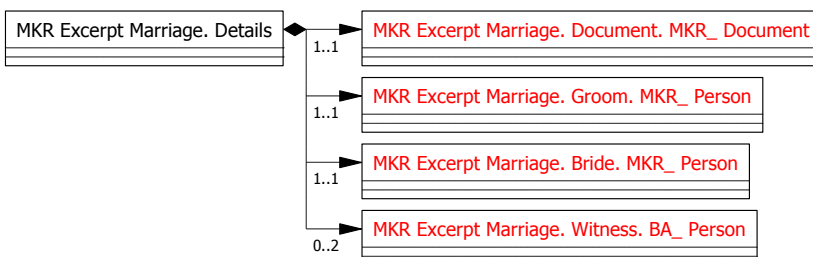

## 3.7 IZVOD IZ MATIČNE KNJIGE UMRLIH

Izvod iz Matične knjige umrlih.

ABIE

### MKR Excerpt Death

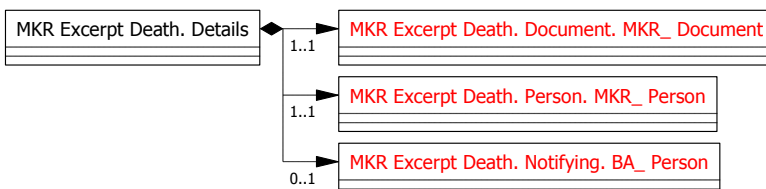

## 3.8 UVJERENJE O DRŽAVLJANSTVU

Uvjerenje o državljanstvu.

ABIE

### Citizenship Certificate

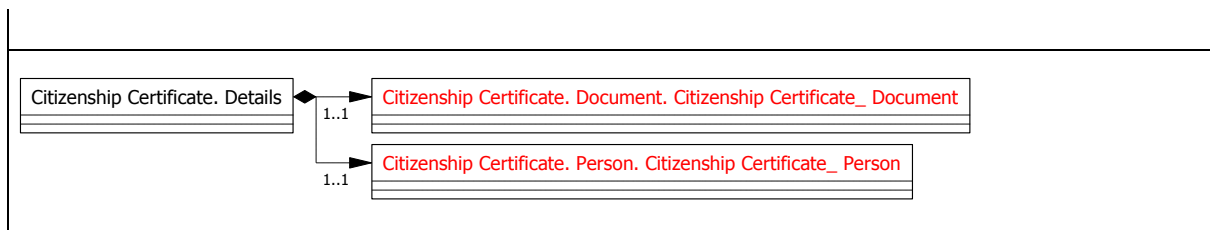

### 3.9 ZAHTJEV ZA UPIS U SUD. REGISTAR – PRAVNA LICA

Zahtjev za upis u sudski registar za pravna lica.

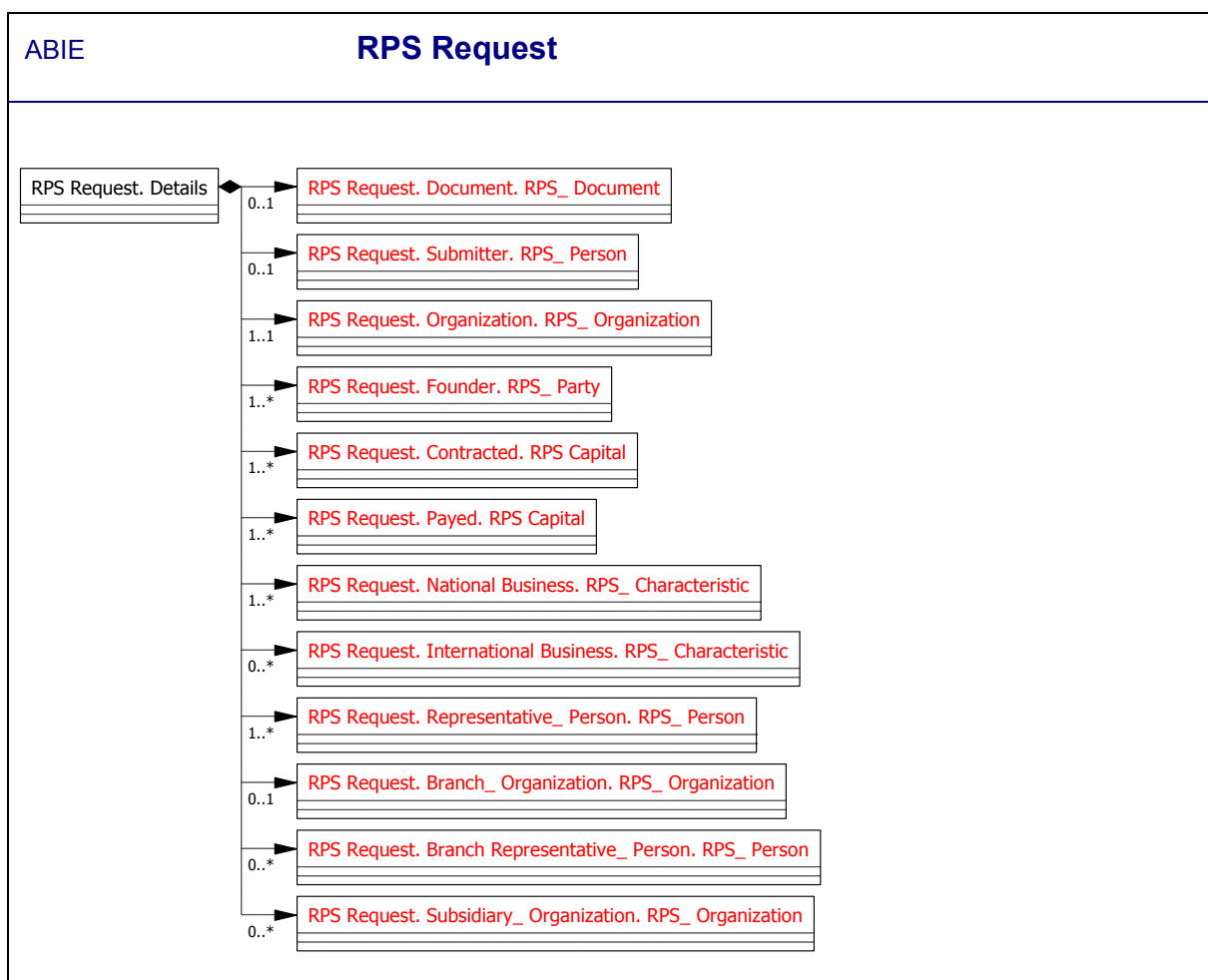

### 3.10 IZVOD IZ SUDSKOG REGISTRA

Izvod iz sudskog registra.





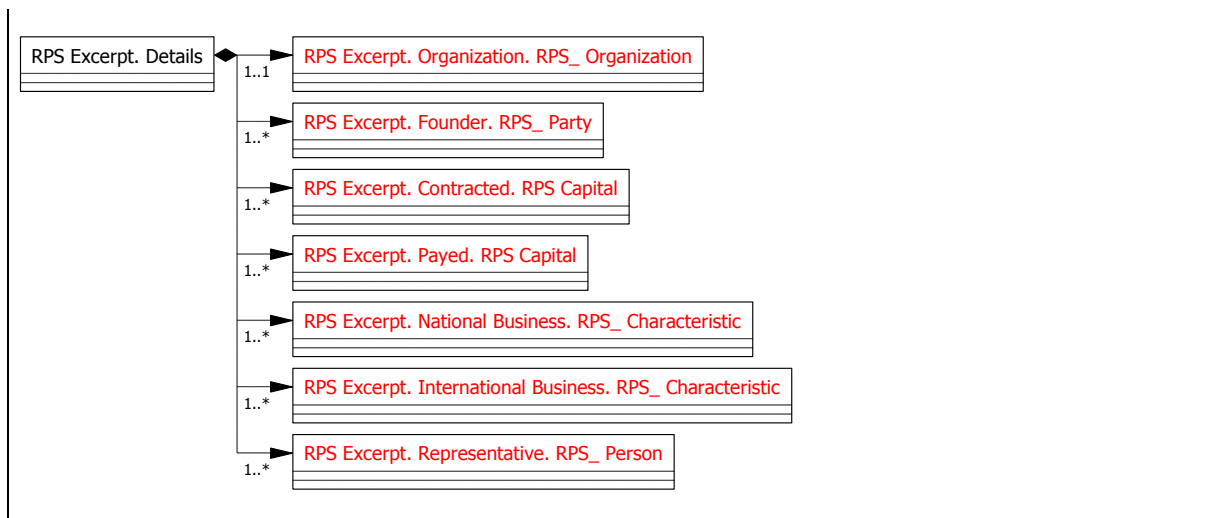

### 3.11 PASOŠ

Dokument – Pasoš.

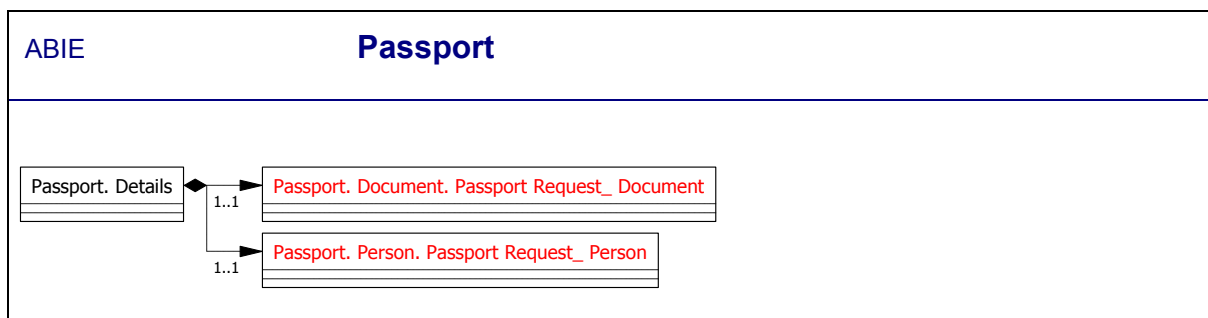

### 3.12 IZVOD IZ EVIDENCIJE JMB

Izvod iz evidencije Jedinstvenog matičnog broja.



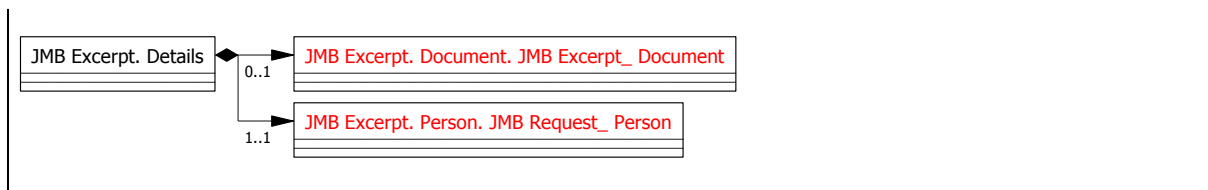

### 3.13 IZVOD IZ EVIDENCIJE LK

Izvod iz evidencije ličnih karti.

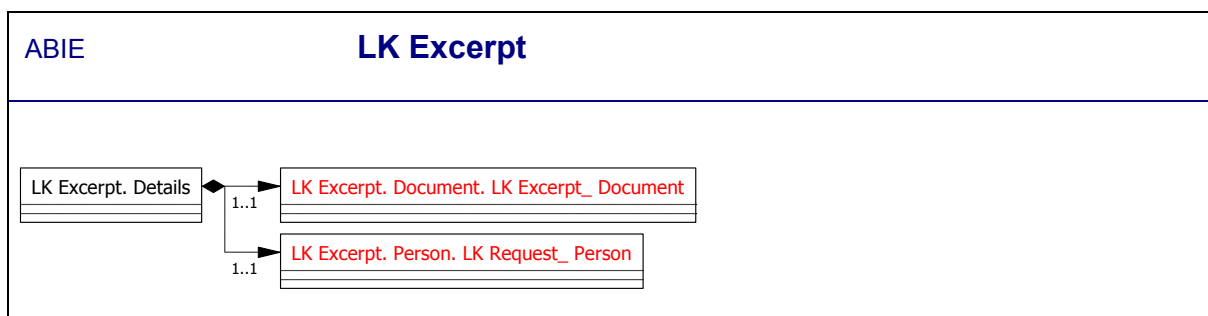

### 3.14 IZVOD IZ EVIDENCIJE VOZAČKIH DOZVOLA

Izvod iz evidencije vozačkih dozvola.

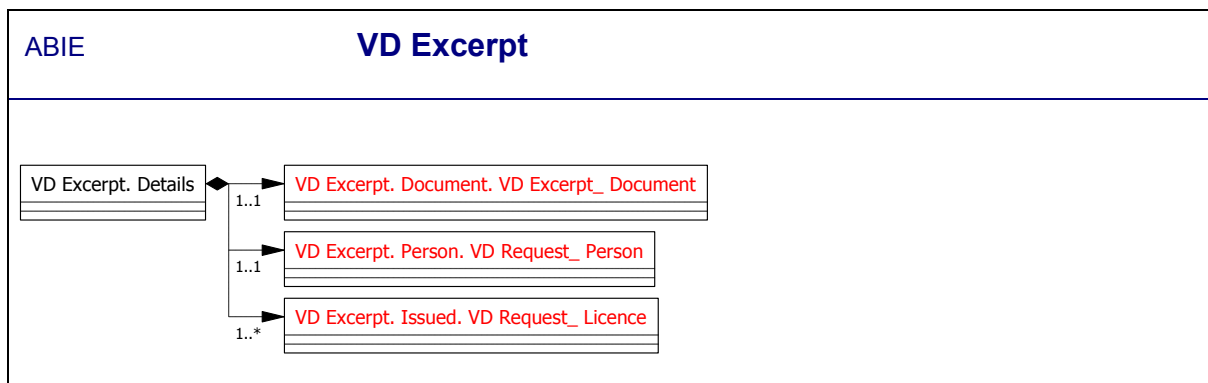

### 3.15 IZVOD IZ EVIDENCIJE PREBIVALIŠTA/BORAVIŠTA

Izvod iz evidencije prebivalište/boravišta.



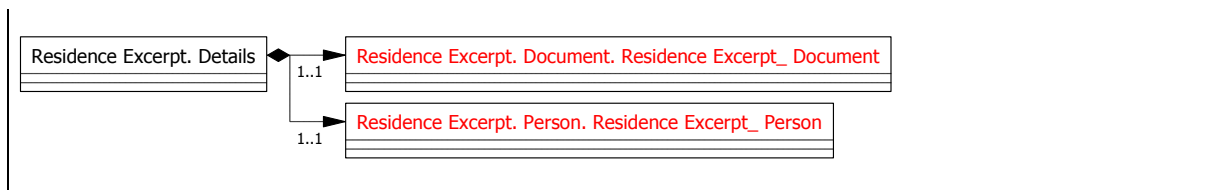

### 3.16 IZVOD IZ EVIDENCIJE VOZILA

Izvod iz evidencije vozila.

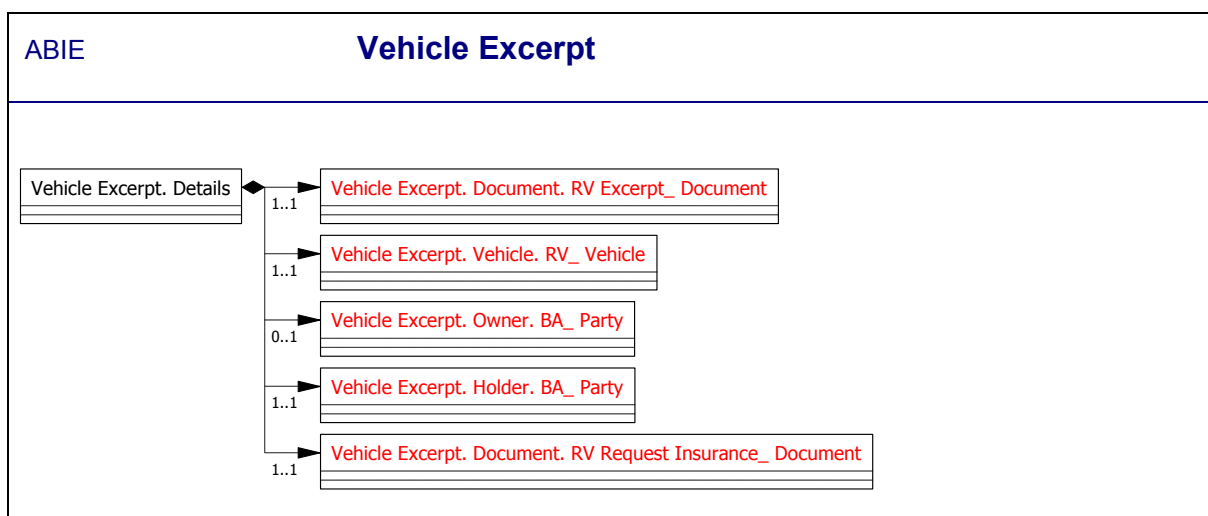

### 3.17 POTVRDA O PLAĆENIM POREZIMA I DOPRINOSIMA

Struktura potvrda o plaćenim porezima i doprinosima.

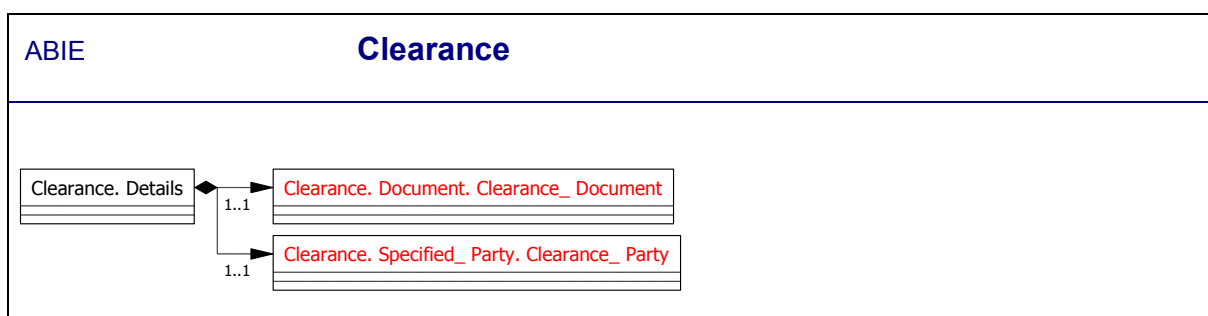

### 3.18 ZDRAVSTVENO OSIGURANJE PRIJAVA/ODJAVA

Zdravstveno osiguranje prijava/odjava.



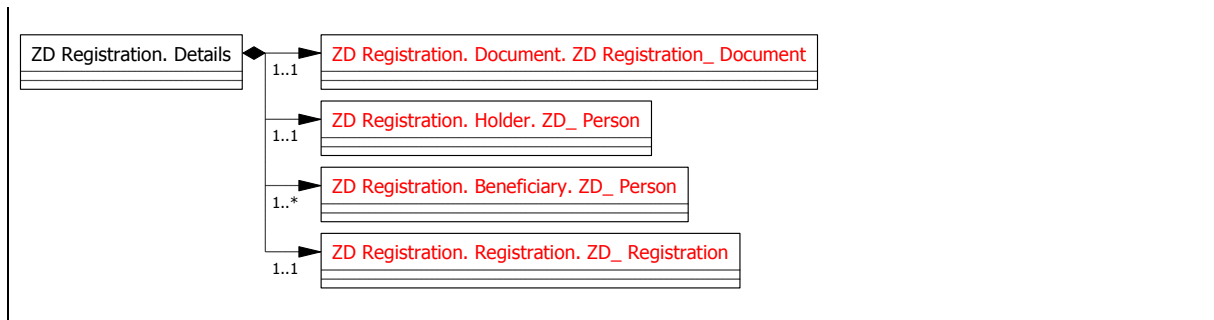

### 3.19 PENZIONO OSIGURANJE PRIJAVA/ODJAVA

Prijava/Odjava za penziono osiguranje.



### 3.20 NALOG ZA PLAĆANJE

Nalog za plaćanje.

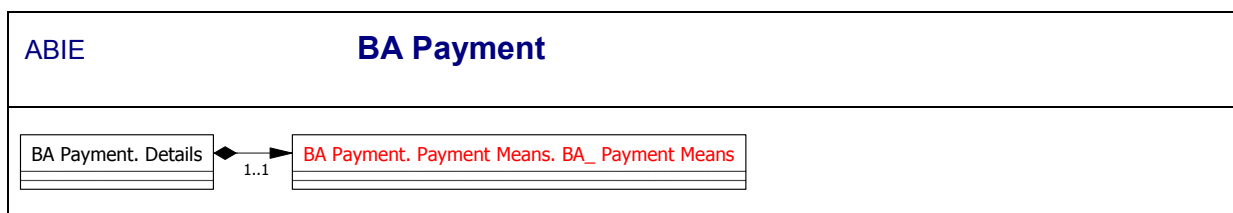

### 3.21 GENERIČKI DOKUMENT

Generički dokument.

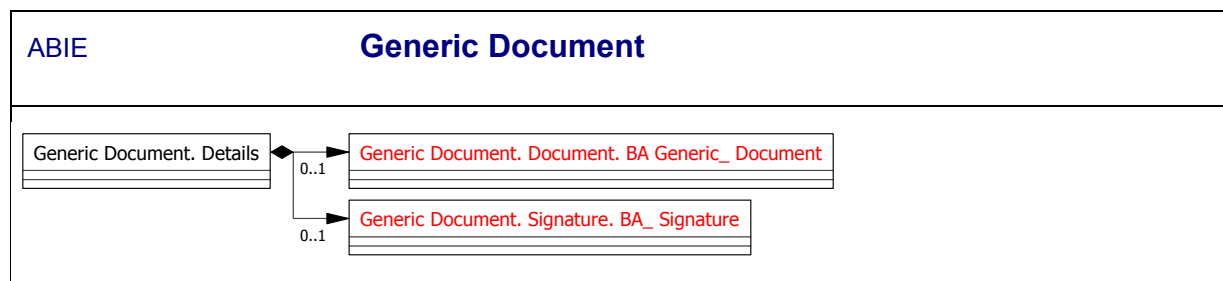

### 3.22 GENERIČKA OVOJNICA PORUKE

Generička ovojnica poruke.

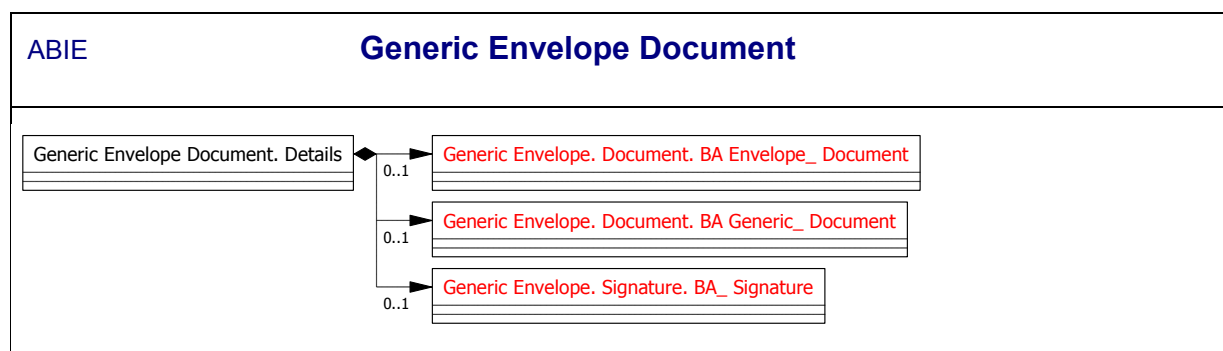

### 3.23 IZVOD IZ REGISTRA PROSTORNIH JEDINICA

Izvod iz registra prostornih jedinica.

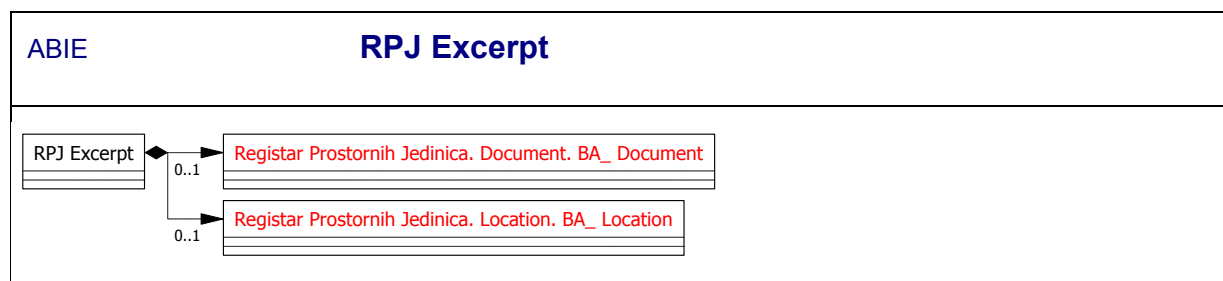

### 3.24 IZVOD IZ ADRESNE EVIDENCIJE

Izvod iz adresne evidencije.

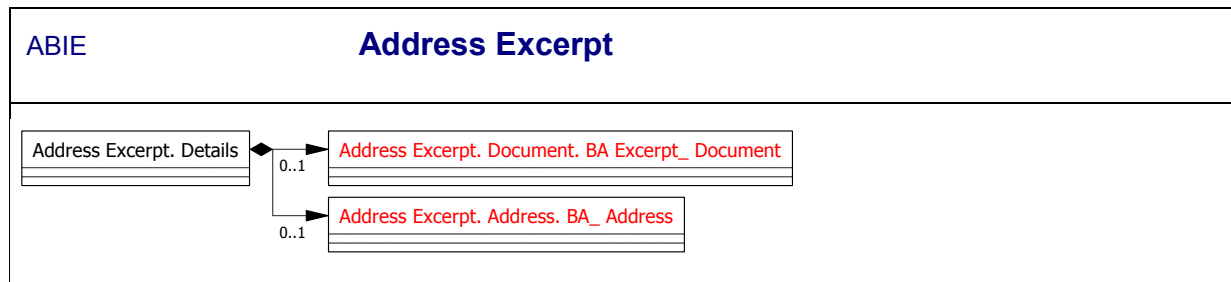

### 3.25 KLASIFIKACIJA

Klasifikacija.

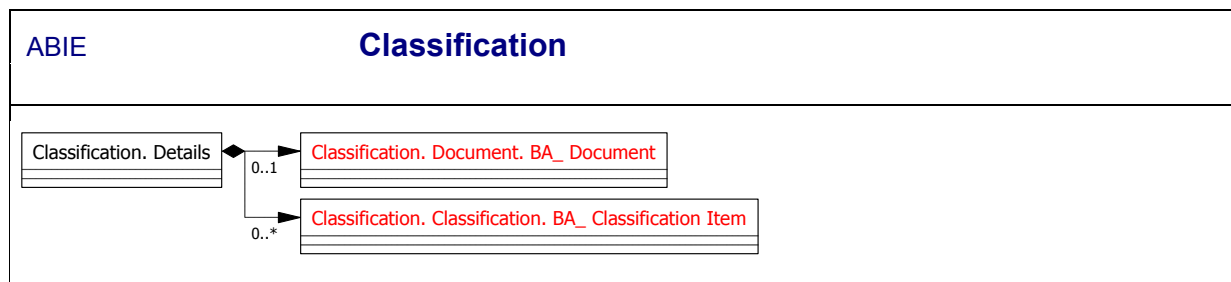



## 4. POSLOVNI INFORMACIONI ENTITETI

Qualified ABIE

### BA\_ Financial Account. Details

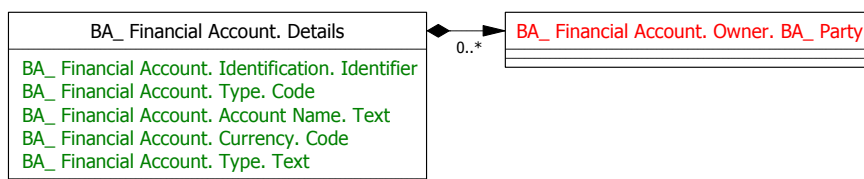

#### Documentation

Naziv	Finansijski Racun
Opis	Skup podataka o finansijskom računu.

#### CCTS

Type	ABIE
Dict.EntryName	BA_ Financial Account. Details
Definition	A specific business arrangement whereby debits and/or credits arising from transactions are recorded, such as, a financial account with a bank, a financial account with a trading partner etc.
Obj.ClassQual.	BA
Obj.ClassTerm	Financial Account
Prop.TermQual.	
Prop.Term	
Repr.TermQual.	
Repr.Term	
Second.Repr.Term	
Assoc.Obj.ClassQual.	
Assoc.Obj.Class	
BusinessTerm(s)	



Qualified ABIE

## BA\_ Payment Means. Details

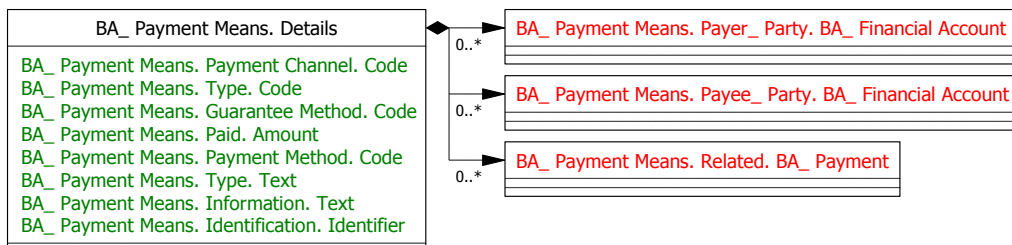

### Documentation

Naziv	Način plaćanja
Opis	Skup podataka o načinu plaćanja

### CCTS

Type	ABIE
Dict.EntryName	BA_ Payment Means. Details
Definition	Details of the means by which the payment will be or has been made.
Obj.ClassQual.	BA
Obj.ClassTerm	Payment Means
Prop.TermQual.	
Prop.Term	
Repr.TermQual.	
Repr.Term	
Second.Repr.Term	
Assoc.Obj.ClassQual.	
Assoc.Obj.Class	
BusinessTerm(s)	





Qualified ABIE

## BA\_ Payment. Details

BA_ Payment. Details
BA_ Payment. Payer Payment_ Instruction. Identifier
BA_ Payment. Payer_ Instruction. Identifier
BA_ Payment. Payee Payment_ Instruction. Identifier
BA_ Payment. Payee_ Instruction. Identifier
BA_ Payment. Received. Date Time
BA_ Payment. Paid. Amount
BA_ Payment. Tax. Amount
BA_ Payment. Creation. Date Time
BA_ Payment. Requested Execution. Date Time
BA_ Payment. Instruction. Code
BA_ Payment. Priority. Code
BA_ Payment. Status. Code
BA_ Payment. Type. Code
BA_ Payment. Reason. Code
BA_ Payment. Due. Date Time
BA_ Payment. Service Level. Code
BA_ Payment. Clearing Channel. Code
BA_ Payment. Entitlement. Indicator

### Documentation

Naziv	BA Plaćanje
Opis	Plaćanje između više strana

### CCTS

Type	ABIE
Dict.EntryName	BA_ Payment. Details
Definition	Discharge obligations in respect of funds or securities transferred between two or more parties. BA-BIE.
Obj.ClassQual.	BA
Obj.ClassTerm	Payment
Prop.TermQual.	
Prop.Term	
Repr.TermQual.	
Repr.Term	
Second.Repr.Term	
Assoc.Obj.ClassQual.	
Assoc.Obj.Class	
BusinessTerm(s)	



Qualified ABIE

## JMB Excerpt\_ Document. Details

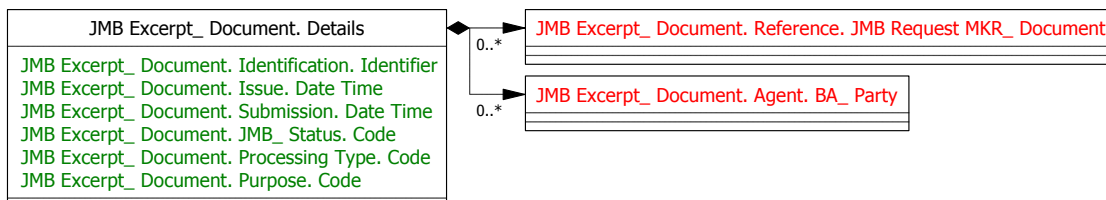

### Documentation

Naziv	JMB Izvadak Dokument
Opis	Izvadak iz JMB evidencije

### CCTS

Type	ABIE
Dict.EntryName	JMB Excerpt_ Document. Details
Definition	A collection of data for a piece of written, printed or electronic matter that provides information or evidence.
Obj.ClassQual.	JMB Excerpt
Obj.ClassTerm	Document
Prop.TermQual.	
Prop.Term	
Repr.TermQual.	
Repr.Term	
Second.Repr.Term	
Assoc.Obj.ClassQual.	
Assoc.Obj.Class	
BusinessTerm(s)	



Qualified ABIE

## JMB Request MKR\_ Document. Details

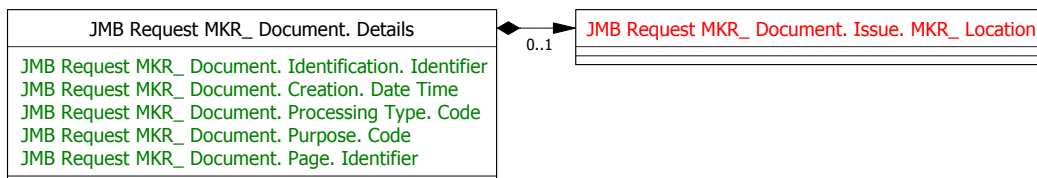

### Documentation

Naziv	JMB Zahtjev MKR Dokument
Opis	Povezani podaci iz matičnih knjiga u JMB evidenciji

### CCTS

Type	ABIE
Dict.EntryName	JMB Request MKR_ Document. Details
Definition	A collection of data for a piece of written, printed or electronic matter that provides information or evidence.
Obj.ClassQual.	JMB Request MKR
Obj.ClassTerm	Document
Prop.TermQual.	
Prop.Term	
Repr.TermQual.	
Repr.Term	
Second.Repr.Term	
Assoc.Obj.ClassQual.	
Assoc.Obj.Class	
BusinessTerm(s)	



Qualified ABIE

## JMB Request\_ Address. Details

JMB Request_ Address. Details
JMB Request_ Address. Format. Code
JMB Request_ Address. Postcode. Code
JMB Request_ Address. Building Number. Text
JMB Request_ Address. Line One. Text
JMB Request_ Address. Street Name. Text
JMB Request_ Address. City Name. Text
JMB Request_ Address. Opstina_ Country Sub-Division Name. Text
JMB Request_ Address. Entitet_ Country Sub-Division Name. Text
JMB Request_ Address. Kanton_ Country Sub-Division Name. Text

### Documentation

Naziv	JMB Zahtjev Adresa
Opis	Podaci o adresi iz JMB evidencije

### CCTS

Type	ABIE
Dict.EntryName	JMB Request_ Address. Details
Definition	The location at which a particular organization or person may be found or reached.
Obj.ClassQual.	JMB Request
Obj.ClassTerm	Address
Prop.TermQual.	
Prop.Term	
Repr.TermQual.	
Repr.Term	
Second.Repr.Term	
Assoc.Obj.ClassQual.	
Assoc.Obj.Class	
BusinessTerm(s)	



Qualified ABIE

## JMB Request\_ Document. Details

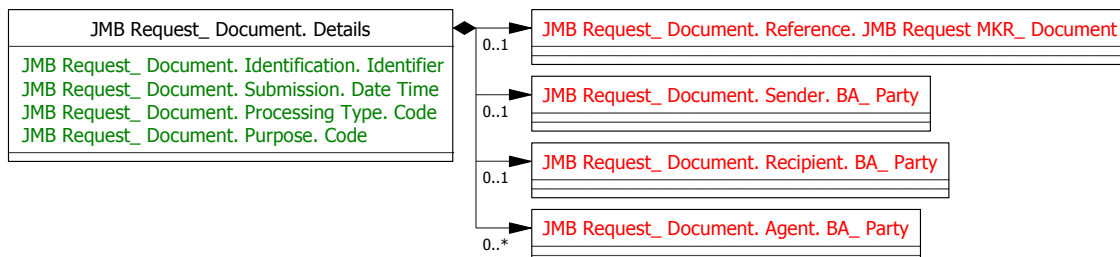

### Documentation

Naziv	JMB Zahtjev Dokument
Opis	Dokument sa zahtjevom za JMB broj

### CCTS

Type	ABIE
Dict.EntryName	JMB Request_ Document. Details
Definition	A collection of data for a piece of written, printed or electronic matter that provides information or evidence.
Obj.ClassQual.	JMB Request
Obj.ClassTerm	Document
Prop.TermQual.	
Prop.Term	
Repr.TermQual.	
Repr.Term	
Second.Repr.Term	
Assoc.Obj.ClassQual.	
Assoc.Obj.Class	
BusinessTerm(s)	



Qualified ABIE

## JMB Request\_ Person. Details

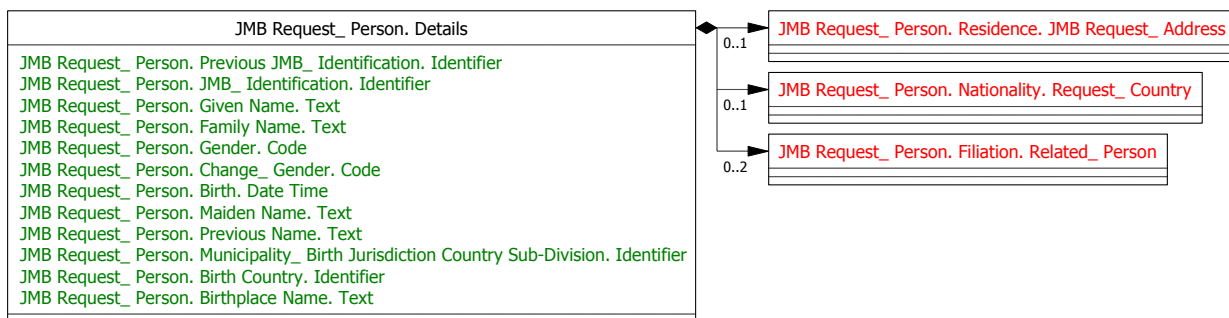

### Documentation

Naziv	JMB Zahtjev Lice
Opis	Podaci o licu iz JMB evidencije

### CCTS

Type	ABIE
Dict.EntryName	JMB Request_ Person. Details
Definition	An individual human being.
Obj.ClassQual.	JMB Request
Obj.ClassTerm	Person
Prop.TermQual.	
Prop.Term	
Repr.TermQual.	
Repr.Term	
Second.Repr.Term	
Assoc.Obj.ClassQual.	
Assoc.Obj.Class	
BusinessTerm(s)	



Qualified ABIE

## LK Excerpt\_ Document. Details

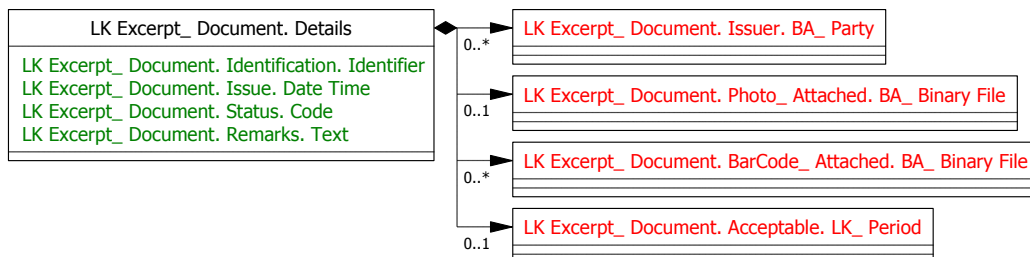

### Documentation

Naziv	Lična Karta Izvadak Dokument
Opis	Izvadak lične karte

### CCTS

Type	ABIE
Dict.EntryName	LK Excerpt_ Document. Details
Definition	A collection of data for a piece of written, printed or electronic matter that provides information or evidence.
Obj.ClassQual.	LK Excerpt
Obj.ClassTerm	Document
Prop.TermQual.	
Prop.Term	
Repr.TermQual.	
Repr.Term	
Second.Repr.Term	
Assoc.Obj.ClassQual.	
Assoc.Obj.Class	
BusinessTerm(s)	



Qualified ABIE

## LK Excerpt\_ Person. Details

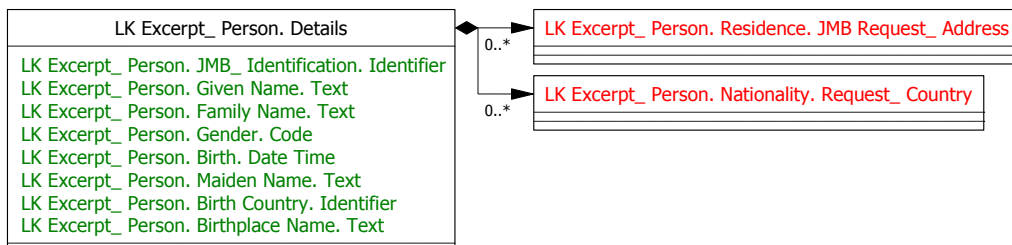

### Documentation

Naziv	Lična Karta Izvadak Lice
Opis	Lice na koje se odnosi izvadak lične karte

### CCTS

Type	ABIE
Dict.EntryName	LK Excerpt_ Person. Details
Definition	An individual human being.
Obj.ClassQual.	LK Excerpt
Obj.ClassTerm	Person
Prop.TermQual.	
Prop.Term	
Repr.TermQual.	
Repr.Term	
Second.Repr.Term	
Assoc.Obj.ClassQual.	
Assoc.Obj.Class	
BusinessTerm(s)	





Qualified ABIE

## LK Previous\_Change. Details

LK Previous_Change. Details
LK Previous_Change. Category. Text
LK Previous_Change. Description. Text
LK Previous_Change. Reason. Text
LK Previous_Change. Subject. Text

### Documentation

Naziv	Lična Karta Prethodne promjene
Opis	Podaci o/razlozi promjene lične karte

### CCTS

Type	ABIE
Dict.EntryName	LK Previous_Change. Details
Definition	An alternation or modification.
Obj.ClassQual.	LK Previous
Obj.ClassTerm	Change
Prop.TermQual.	
Prop.Term	
Repr.TermQual.	
Repr.Term	
Second.Repr.Term	
Assoc.Obj.ClassQual.	
Assoc.Obj.Class	
BusinessTerm(s)	



Qualified ABIE

## LK Previous\_ Document. Details

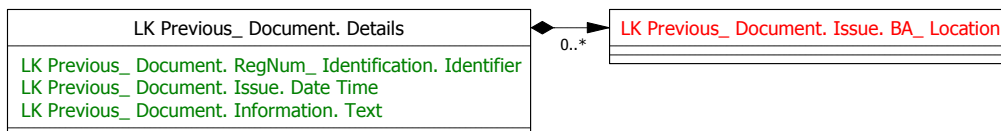

### Documentation

Naziv	Lična Karta Prethodni Dokument
Opis	Podaci o prethodnoj ličnoj karti

### CCTS

Type	ABIE
Dict.EntryName	LK Previous_ Document. Details
Definition	A collection of data for a piece of written, printed or electronic matter that provides information or evidence.
Obj.ClassQual.	LK Previous
Obj.ClassTerm	Document
Prop.TermQual.	
Prop.Term	
Repr.TermQual.	
Repr.Term	
Second.Repr.Term	
Assoc.Obj.ClassQual.	
Assoc.Obj.Class	
BusinessTerm(s)	



Qualified ABIE

## LK Request\_ Address. Details

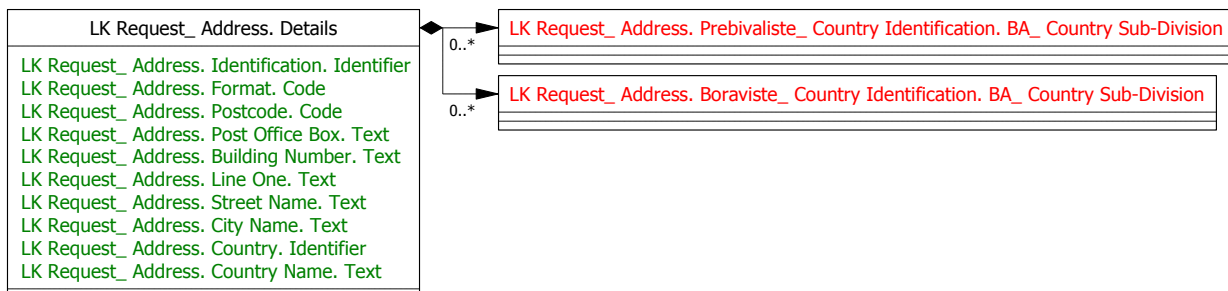

### Documentation

Naziv	Lična Karta Zahtjev Adresa
Opis	Podaci o adresi iz zahtjeva za ličnom kartom

### CCTS

Type	ABIE
Dict.EntryName	LK Request_ Address. Details
Definition	The location at which a particular organization or person may be found or reached.
Obj.ClassQual.	LK Request
Obj.ClassTerm	Address
Prop.TermQual.	
Prop.Term	
Repr.TermQual.	
Repr.Term	
Second.Repr.Term	
Assoc.Obj.ClassQual.	
Assoc.Obj.Class	
BusinessTerm(s)	



Qualified ABIE

## LK Request\_ Document. Details

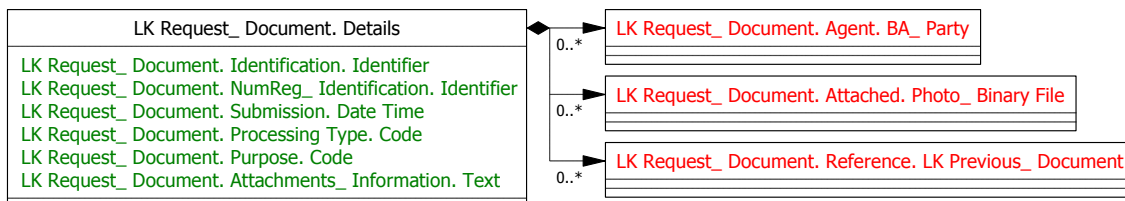

### Documentation

Naziv	Lična Karta Zahtjev Dokument
Opis	Dokument zahtjeva za izdavanjem lične karte

### CCTS

Type	ABIE
Dict.EntryName	LK Request_ Document. Details
Definition	A collection of data for a piece of written, printed or electronic matter that provides information or evidence.
Obj.ClassQual.	LK Request
Obj.ClassTerm	Document
Prop.TermQual.	
Prop.Term	
Repr.TermQual.	
Repr.Term	
Second.Repr.Term	
Assoc.Obj.ClassQual.	
Assoc.Obj.Class	
BusinessTerm(s)	



Qualified ABIE

## LK Request\_ Person. Details

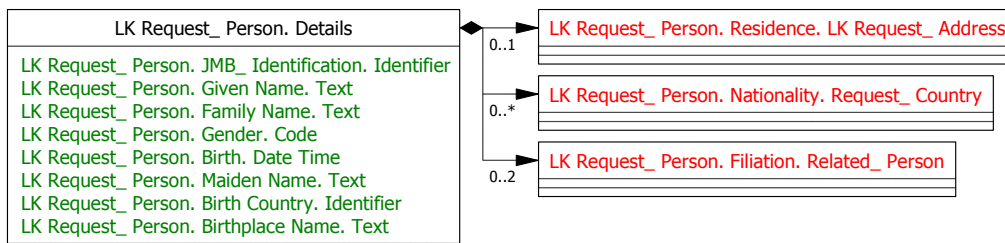

### Documentation

Naziv	Lična Karta Zahtjev Lice
Opis	Podaci o licu za koje se podnosi zahtjev za izdavanje/promjenu lične karte

### CCTS

Type	ABIE
Dict.EntryName	LK Request_ Person. Details
Definition	An individual human being.
Obj.ClassQual.	LK Request
Obj.ClassTerm	Person
Prop.TermQual.	
Prop.Term	
Repr.TermQual.	
Repr.Term	
Second.Repr.Term	
Assoc.Obj.ClassQual.	
Assoc.Obj.Class	
BusinessTerm(s)	



Qualified ABIE

## LK\_Period. Details

LK_Period. Details
LK_Period. Duration. Measure
LK_Period. Description. Text
LK_Period. Start. Date Time
LK_Period. End. Date Time

### Documentation

Naziv	Lična Karta Period
Opis	Vremenski period koji se koristi u evidenciji ličnih karata

### CCTS

Type	ABIE
Dict.EntryName	LK_Period. Details
Definition	A specific period of time such as the length of time between two known date/time points, from a start date onwards, or up to an end date.
Obj.ClassQual.	LK
Obj.ClassTerm	Period
Prop.TermQual.	
Prop.Term	
Repr.TermQual.	
Repr.Term	
Second.Repr.Term	
Assoc.Obj.ClassQual.	
Assoc.Obj.Class	
BusinessTerm(s)	



Qualified ABIE

## MKR\_ Address. Details

MKR_ Address. Details
MKR_ Address. Format. Code
MKR_ Address. Postcode. Code
MKR_ Address. Building Number. Text
MKR_ Address. Floor Identification. Text
MKR_ Address. Line One. Text
MKR_ Address. Street Name. Text
MKR_ Address. City Name. Text
MKR_ Address. Country Sub-Division Name. Text

### Documentation

Naziv	Matična Knjiga Adresa
Opis	Podaci o adresi u matičnim knjigama

### CCTS

Type	ABIE
Dict.EntryName	MKR_ Address. Details
Definition	The location at which a particular organization or person may be found or reached.
Obj.ClassQual.	MKR
Obj.ClassTerm	Address
Prop.TermQual.	
Prop.Term	
Repr.TermQual.	
Repr.Term	
Second.Repr.Term	
Assoc.Obj.ClassQual.	
Assoc.Obj.Class	
BusinessTerm(s)	

Qualified ABIE

## MKR\_ Document. Details

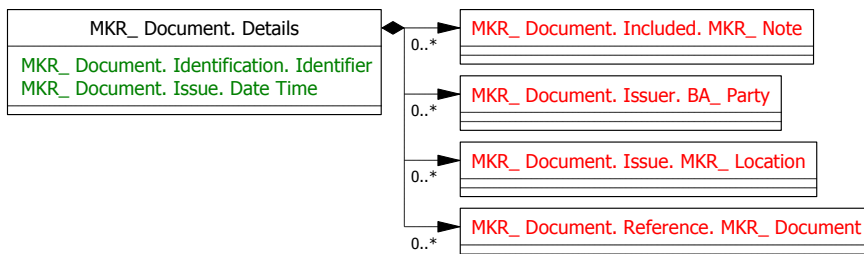

### Documentation

Naziv	Matična Knjiga Dokument
Opis	Dokument iz matičnih knjiga

### CCTS

Type	ABIE
Dict.EntryName	MKR_ Document. Details
Definition	A collection of data for a piece of written, printed or electronic matter that provides information or evidence.
Obj.ClassQual.	MKR
Obj.ClassTerm	Document
Prop.TermQual.	
Prop.Term	
Repr.TermQual.	
Repr.Term	
Second.Repr.Term	
Assoc.Obj.ClassQual.	
Assoc.Obj.Class	
BusinessTerm(s)	





Qualified ABIE

## MKR\_ Event. Details

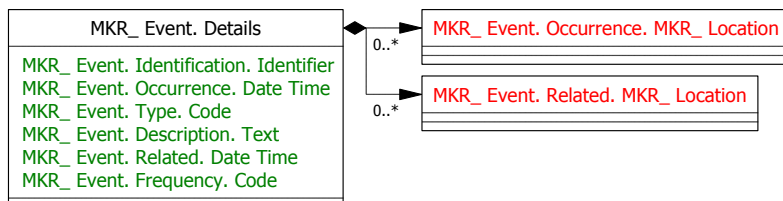

### Documentation

Naziv	Matična Knjiga Događaj
Opis	Podaci o događaju (rođenje/smrt/vjenčanje) u matičnim knjigama

### CCTS

Type	ABIE
Dict.EntryName	MKR_ Event. Details
Definition	A significant occurrence or happening related to an object process, or person.
Obj.ClassQual.	MKR
Obj.ClassTerm	Event
Prop.TermQual.	
Prop.Term	
Repr.TermQual.	
Repr.Term	
Second.Repr.Term	
Assoc.Obj.ClassQual.	
Assoc.Obj.Class	
BusinessTerm(s)	



Qualified ABIE

## MKR\_ Location. Details

MKR_ Location. Details
MKR_ Location. Identification. Identifier
MKR_ Location. Name. Text
MKR_ Location. Type. Code
MKR_ Location. Description. Text
MKR_ Location. District. Identifier
MKR_ Location. Country Name. Text
MKR_ Location. Country Sub-Division Name. Text
MKR_ Location. Geopolitical Region Name. Text

### Documentation

Naziv	Matična Knjiga Lokacija
Opis	Podaci o lokaciji u matičnim knjigama

### CCTS

Type	ABIE
Dict.EntryName	MKR_ Location. Details
Definition	A physical location or place.
Obj.ClassQual.	MKR
Obj.ClassTerm	Location
Prop.TermQual.	
Prop.Term	
Repr.TermQual.	
Repr.Term	
Second.Repr.Term	
Assoc.Obj.ClassQual.	
Assoc.Obj.Class	
BusinessTerm(s)	



Qualified ABIE

## MKR\_ Note. Details

MKR_ Note. Details
MKR_ Note. Subject. Text
MKR_ Note. Content. Text
MKR_ Note. Identification. Identifier
MKR_ Note. Name. Text
MKR_ Note. Creation. Date Time

### Documentation

Naziv	Matična Knjiga Napomena
Opis	Napomena u matičnim knjigama

### CCTS

Type	ABIE
Dict.EntryName	MKR_ Note. Details
Definition	A textual or coded description, such as a remark or additional information.
Obj.ClassQual.	MKR
Obj.ClassTerm	Note
Prop.TermQual.	
Prop.Term	
Repr.TermQual.	
Repr.Term	
Second.Repr.Term	
Assoc.Obj.ClassQual.	
Assoc.Obj.Class	
BusinessTerm(s)	

Qualified ABIE

### MKR\_ Person. Details

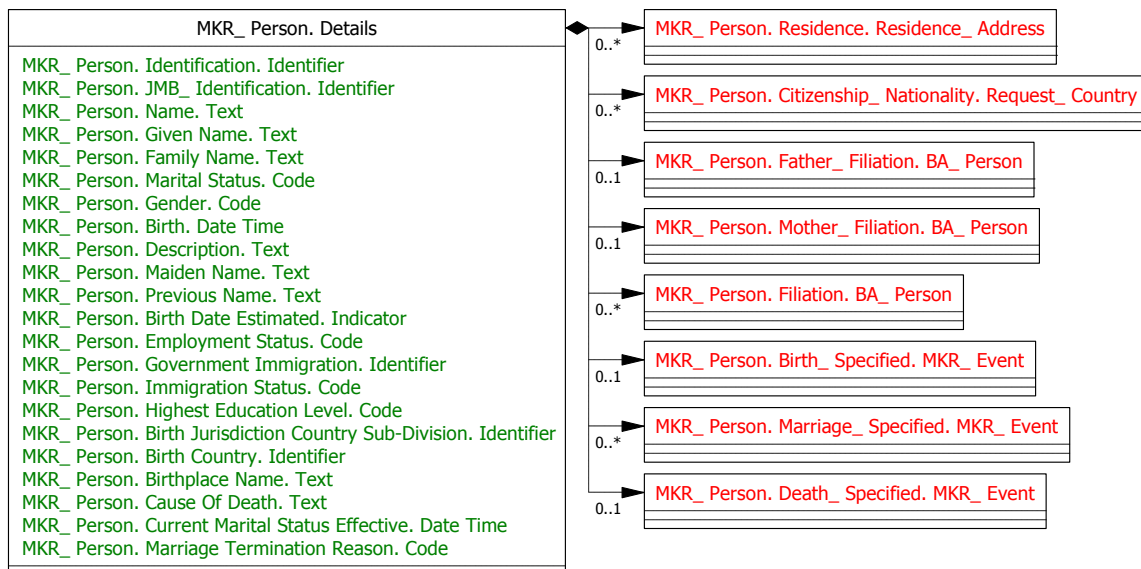

### Documentation

Naziv	Matična knjiga Lice
Opis	Podaci o licu u matičnim knjigama

### CCTS

Type	ABIE
Dict.EntryName	MKR_ Person. Details
Definition	An individual human being.
Obj.ClassQual.	MKR
Obj.ClassTerm	Person
Prop.TermQual.	
Prop.Term	
Repr.Term	
Assoc.Obj.ClassQual.	
Assoc.Obj.Class	
BusinessTerm(s)	



Qualified ABIE

## Passport Previous\_ Document. Details

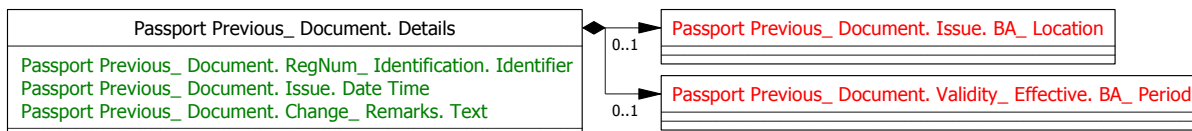

### Documentation

Naziv	Pasoš Prethodni Dokument
Opis	Podaci o prethodnom pasošu

### CCTS

Type	ABIE
Dict.EntryName	Passport Previous_ Document. Details
Definition	A collection of data for a piece of written, printed or electronic matter that provides information or evidence.
Obj.ClassQual.	Passport Previous
Obj.ClassTerm	Document
Prop.TermQual.	
Prop.Term	
Repr.TermQual.	
Repr.Term	
Second.Repr.Term	
Assoc.Obj.ClassQual.	
Assoc.Obj.Class	
BusinessTerm(s)	



Qualified ABIE

## Passport Request\_ Document. Details

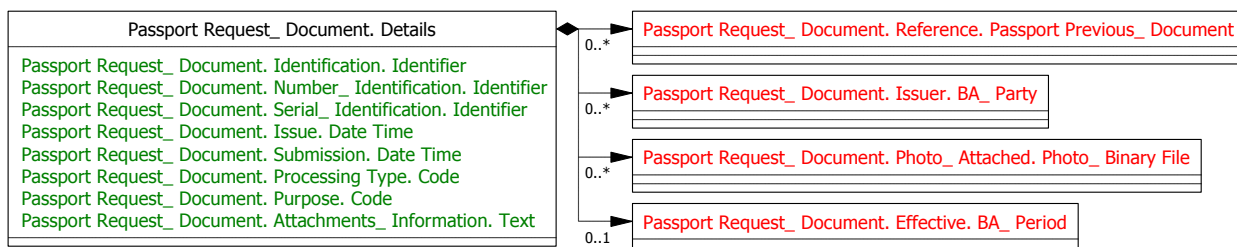

### Documentation

Naziv	Pasoš Zahtjev Dokument
Opis	Dokument zahtjeva za izdavanjem pasoša

### CCTS

Type	ABIE
Dict.EntryName	Passport Request_ Document. Details
Definition	A collection of data for a piece of written, printed or electronic matter that provides information or evidence.
Obj.ClassQual.	Passport Request
Obj.ClassTerm	Document
Prop.TermQual.	
Prop.Term	
Repr.TermQual.	
Repr.Term	
Second.Repr.Term	
Assoc.Obj.ClassQual.	
Assoc.Obj.Class	
BusinessTerm(s)	



Qualified ABIE

## Passport Request\_ Person. Details

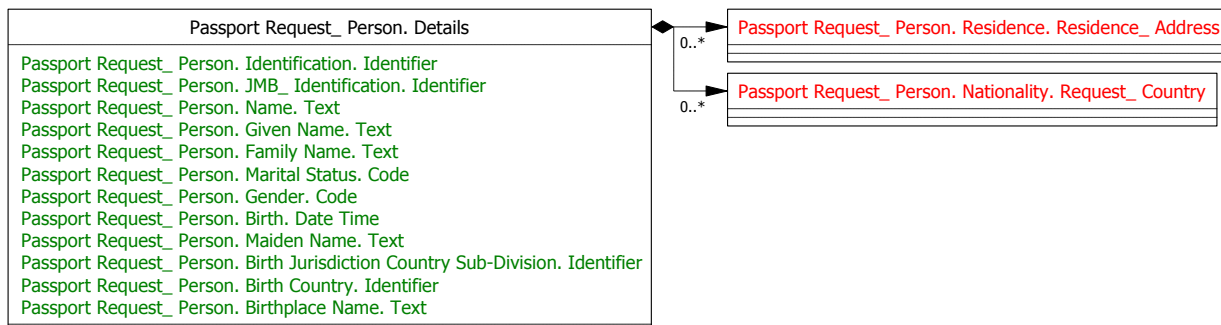

### Documentation

Naziv	Pasoš Zahtjev Lice
Opis	Skup podataka o licu u pasošu

### CCTS

Type	ABIE
Dict.EntryName	Passport Request_ Person. Details
Definition	An individual human being.
Obj.ClassQual.	Passport Request
Obj.ClassTerm	Person
Prop.TermQual.	
Prop.Term	
Repr.TermQual.	
Repr.Term	
Second.Repr.Term	
Assoc.Obj.ClassQual.	
Assoc.Obj.Class	
BusinessTerm(s)	

ABIE

**RPS Capital. Details**

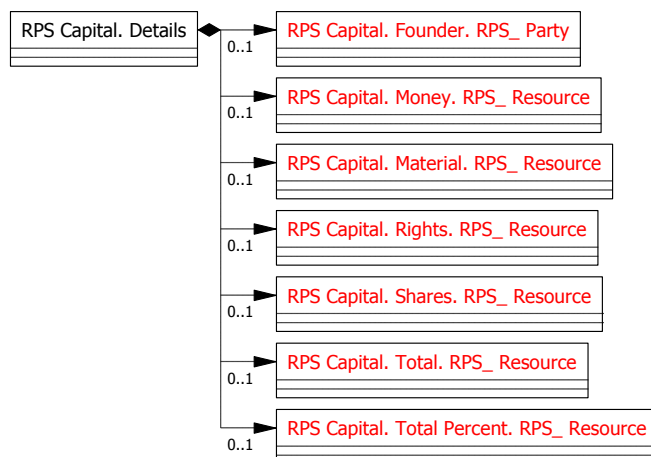

**Documentation**

Naziv	Registar Poslovnih Subjekata Kapital
Opis	Podaci o kapitalu iz registra poslovnih subjekata

**CCTS**

Type	ABIE
Dict.EntryName	RPS Capital. Details
Definition	
Obj.ClassQual.	
Obj.ClassTerm	RPS Capital
Prop.TermQual.	
Prop.Term	
Repr.TermQual.	
Repr.Term	
Second.Repr.Term	
Assoc.Obj.ClassQual.	
Assoc.Obj.Class	
BusinessTerm(s)	





Qualified ABIE

## RPS\_ Characteristic. Details

RPS_ Characteristic. Details
RPS_ Characteristic. Type. Code
RPS_ Characteristic. Description. Text

### Documentation

Naziv	Registar Poslovnih Subjekata Karakteristika
Opis	Skup podataka o nekoj karakteristici poslovnog subjekta.

### CCTS

Type	ABIE
Dict.EntryName	RPS_ Characteristic. Details
Definition	A prominent attribute or aspect.
Obj.ClassQual.	RPS
Obj.ClassTerm	Characteristic
Prop.TermQual.	
Prop.Term	
Repr.TermQual.	
Repr.Term	
Second.Repr.Term	
Assoc.Obj.ClassQual.	
Assoc.Obj.Class	
BusinessTerm(s)	



Qualified ABIE

## RPS\_ Document. Details

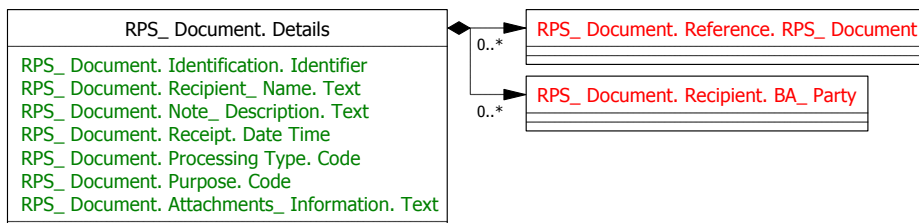

### Documentation

Naziv	Registar Poslovnih Subjekata Dokument
Opis	Dokument iz registra poslovnih subjekata

### CCTS

Type	ABIE
Dict.EntryName	RPS_ Document. Details
Definition	A collection of data for a piece of written, printed or electronic matter that provides information or evidence.
Obj.ClassQual.	RPS
Obj.ClassTerm	Document
Prop.TermQual.	
Prop.Term	
Repr.TermQual.	
Repr.Term	
Second.Repr.Term	
Assoc.Obj.ClassQual.	
Assoc.Obj.Class	
BusinessTerm(s)	



Qualified ABIE

## RPS\_ Organization. Details

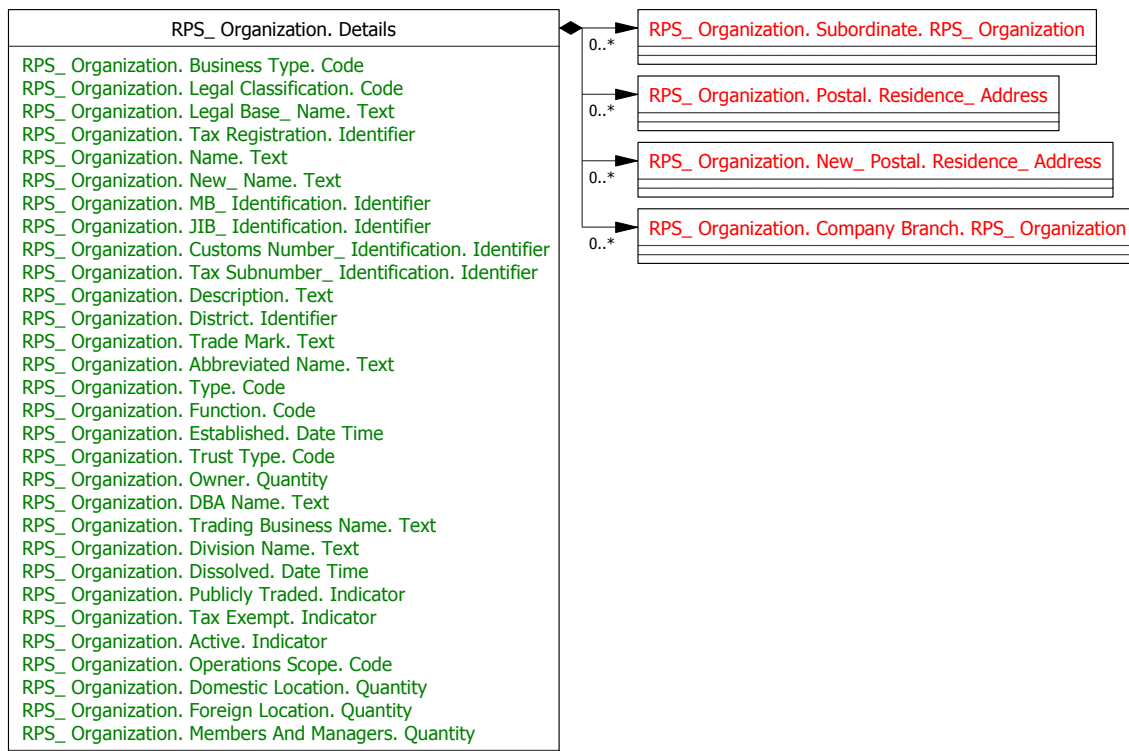

### Documentation

Naziv	Registar Poslovnih Subjekata Organizacija
Opis	Podaci o organizaciji iz registra poslovnih subjekata

### CCTS

Type	ABIE
Dict.EntryName	RPS_ Organization. Details
Definition	An organized structure set up for a particular purpose, such as a business, government body, department, charity, or financial institution.
Obj.ClassQual.	RPS
Obj.ClassTerm	Organization
Prop.TermQual.	
Prop.Term	



PROJEKT  
IZRADA I USPOSTAVLJANJE OKVIRA INTEROPERABILNOSTI I  
STANDARDA ZA RAZMJENU PODATAKA  
**INICIJALNI RJEČNIK PODATAKA**

Oznaka:  
PARCO-IFBIH

Page: 52 of 124

Repr.TermQual.	
Repr.Term	
Second.Repr.Term	
Assoc.Obj.ClassQual.	
Assoc.Obj.Class	
BusinessTerm(s)	



Qualified ABIE

## RPS\_ Party. Details

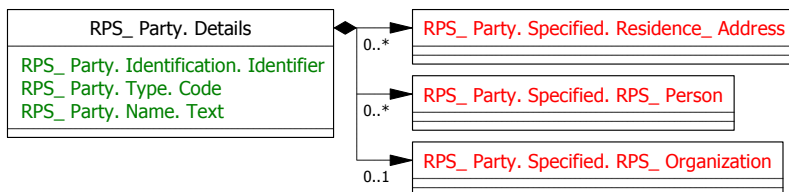

### Documentation

Naziv	Registar Poslovnih Subjekata Stranka
Opis	Podaci o stranki u registru poslovnih subjekata

### CCTS

Type	ABIE
Dict.EntryName	RPS_ Party. Details
Definition	An individual, a group, or a body having a role in a business function. Party has a legal connotation in a business transaction.
Obj.ClassQual.	RPS
Obj.ClassTerm	Party
Prop.TermQual.	
Prop.Term	
Repr.TermQual.	
Repr.Term	
Second.Repr.Term	
Assoc.Obj.ClassQual.	
Assoc.Obj.Class	
BusinessTerm(s)	



Qualified ABIE

## RPS\_ Person. Details

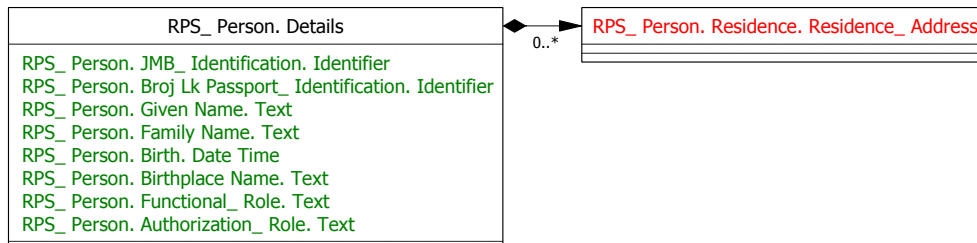

### Documentation

Naziv	Registar Poslovnih Subjekata Lica
Opis	Podaci o licu u registru poslovnih subjekata

### CCTS

Type	ABIE
Dict.EntryName	RPS_ Person. Details
Definition	An individual human being.
Obj.ClassQual.	RPS
Obj.ClassTerm	Person
Prop.TermQual.	
Prop.Term	
Repr.TermQual.	
Repr.Term	
Second.Repr.Term	
Assoc.Obj.ClassQual.	
Assoc.Obj.Class	
BusinessTerm(s)	



Qualified ABIE

## RPS\_ Resource. Details

RPS_ Resource. Details
RPS_ Resource. Identification. Identifier
RPS_ Resource. Name. Text
RPS_ Resource. Description. Text
RPS_ Resource. Type. Code
RPS_ Resource. Availability. Quantity
RPS_ Resource. Unit Cost. Amount
RPS_ Resource. Unit Cost Measure. Code
RPS_ Resource. Category. Code

### Documentation

Naziv	Registar Poslovnih Subjekata Resurs
Opis	Podaci o resursu u registru poslovnih subjekata

### CCTS

Type	ABIE
Dict.EntryName	RPS_ Resource. Details
Definition	A stock or supply of people, materials, or assets.
Obj.ClassQual.	RPS
Obj.ClassTerm	Resource
Prop.TermQual.	
Prop.Term	
Repr.TermQual.	
Repr.Term	
Second.Repr.Term	
Assoc.Obj.ClassQual.	
Assoc.Obj.Class	
BusinessTerm(s)	



Qualified ABIE

## VD Excerpt\_ Document. Details

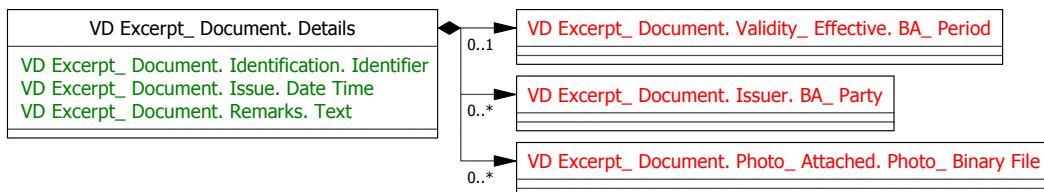

### Documentation

Naziv	Vozacka Dozvola Izvadak Dokument
Opis	Dokument-Izvadak vozačke dozvole

### CCTS

Type	ABIE
Dict.EntryName	VD Excerpt_ Document. Details
Definition	A collection of data for a piece of written, printed or electronic matter that provides information or evidence.
Obj.ClassQual.	VD Excerpt
Obj.ClassTerm	Document
Prop.TermQual.	
Prop.Term	
Repr.TermQual.	
Repr.Term	
Second.Repr.Term	
Assoc.Obj.ClassQual.	
Assoc.Obj.Class	
BusinessTerm(s)	





Qualified ABIE

## VD Request\_ Licence. Details

VD Request_ Licence. Details
VD Request_ Licence. Type. Code
VD Request_ Licence. Category. Code
VD Request_ Licence. Held Duration. Measure
VD Request_ Licence. Restriction. Indicator
VD Request_ Licence. Authority Assigned Identification. Identifier
VD Request_ Licence. Test Passed. Date Time
VD Request_ Licence. Suspension Revocation. Date Time
VD Request_ Licence. Suspension Revocation Reason. Code
VD Request_ Licence. Place_ Test Passed Country. Identifier

### Documentation

Naziv	Vozacka Dozvola Zahtjev Dozvola
Opis	Detaljni podaci o dozvoli

### CCTS

Type	ABIE
Dict.EntryName	VD Request_ Licence. Details
Definition	A permit from an authority to own or use something, do a particular thing, or carry on a trade.
Obj.ClassQual.	VD Request
Obj.ClassTerm	Licence
Prop.TermQual.	
Prop.Term	
Repr.TermQual.	
Repr.Term	
Second.Repr.Term	
Assoc.Obj.ClassQual.	
Assoc.Obj.Class	
BusinessTerm(s)	



Qualified ABIE

## VD Request\_Person. Details

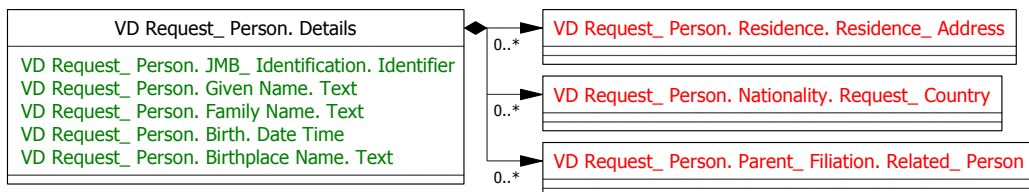

### Documentation

Naziv	Vozacka Dozvola Zahtjev Lice
Opis	Podaci o licu za vozačku dozvolu

### CCTS

Type	ABIE
Dict.EntryName	VD Request_Person. Details
Definition	An individual human being.
Obj.ClassQual.	VD Request
Obj.ClassTerm	Person
Prop.TermQual.	
Prop.Term	
Repr.TermQual.	
Repr.Term	
Second.Repr.Term	
Assoc.Obj.ClassQual.	
Assoc.Obj.Class	
BusinessTerm(s)	



Qualified ABIE

## VD Request\_ Document. Details

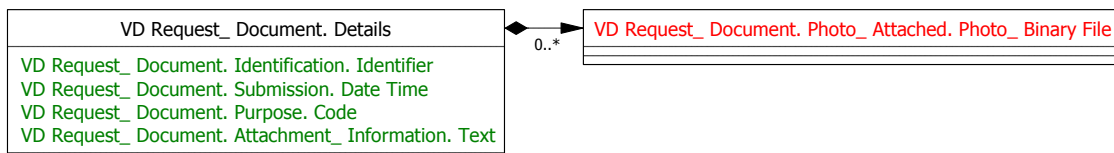

### Documentation

Naziv	Vozacka Dozvola Zahtjev Dokument
Opis	Dokument zahtjeva za izdavanje/zamjenu vozačke dozvole

### CCTS

Type	ABIE
Dict.EntryName	VD Request_ Document. Details
Definition	A collection of data for a piece of written, printed or electronic matter that provides information or evidence.
Obj.ClassQual.	VD Request
Obj.ClassTerm	Document
Prop.TermQual.	
Prop.Term	
Repr.TermQual.	
Repr.Term	
Second.Repr.Term	
Assoc.Obj.ClassQual.	
Assoc.Obj.Class	
BusinessTerm(s)	



Qualified ABIE

## Residence Excerpt\_ Document. Details

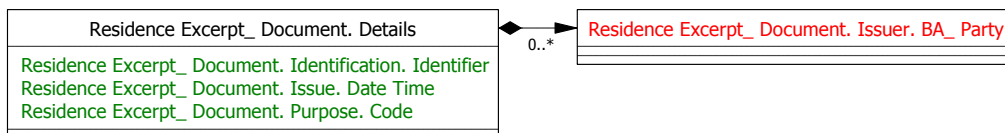

### Documentation

Naziv	Prebivaliste Izvadak Dokument
Opis	Dokument iz evidencije prebivališta/boravišta

### CCTS

Type	ABIE
Dict.EntryName	Residence Excerpt_ Document. Details
Definition	A collection of data for a piece of written, printed or electronic matter that provides information or evidence.
Obj.ClassQual.	Residence Excerpt
Obj.ClassTerm	Document
Prop.TermQual.	
Prop.Term	
Repr.TermQual.	
Repr.Term	
Second.Repr.Term	
Assoc.Obj.ClassQual.	
Assoc.Obj.Class	
BusinessTerm(s)	



Qualified ABIE

## Residence Excerpt\_Person. Details

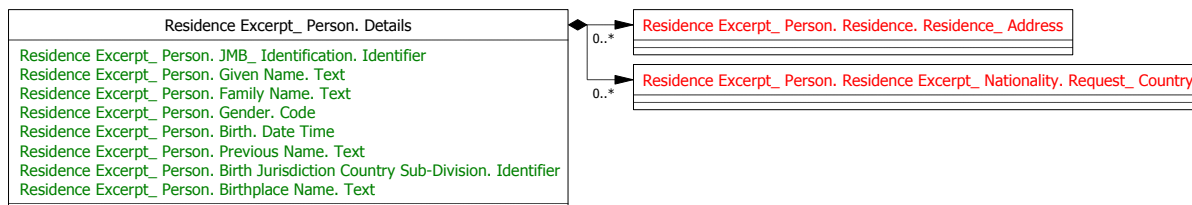

### Documentation

Naziv	Prebivalište Izvadak Lice
Opis	Podaci o licu u evidenciji prebivališta/boravišta

### CCTS

Type	ABIE
Dict.EntryName	Residence Excerpt_Person. Details
Definition	An individual human being.
Obj.ClassQual.	Residence Excerpt
Obj.ClassTerm	Person
Prop.TermQual.	
Prop.Term	
Repr.TermQual.	
Repr.Term	
Second.Repr.Term	
Assoc.Obj.ClassQual.	
Assoc.Obj.Class	
BusinessTerm(s)	



Qualified ABIE

## RV Excerpt\_ Document. Details

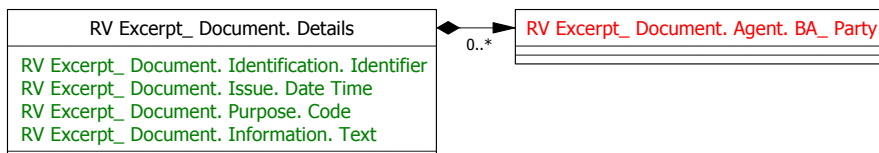

### Documentation

Naziv	Registar Vozila Izvadak Dokument
Opis	Izvadak iz registra vozila

### CCTS

Type	ABIE
Dict.EntryName	RV Excerpt_ Document. Details
Definition	A collection of data for a piece of written, printed or electronic matter that provides information or evidence.
Obj.ClassQual.	RV Excerpt
Obj.ClassTerm	Document
Prop.TermQual.	
Prop.Term	
Repr.TermQual.	
Repr.Term	
Second.Repr.Term	
Assoc.Obj.ClassQual.	
Assoc.Obj.Class	
BusinessTerm(s)	



Qualified ABIE

## RV Request Insurance\_ Document. Details

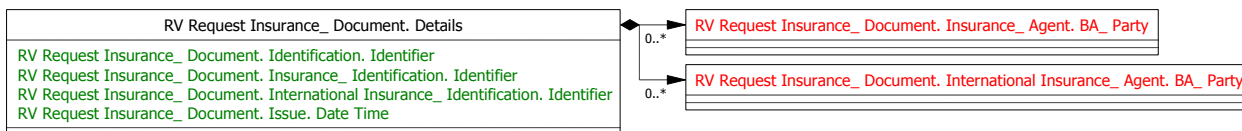

### Documentation

Naziv	Registar Vozila Zahtjev Osiguranje
Opis	Podaci o osiguranju vozila.

### CCTS

Type	ABIE
Dict.EntryName	RV Request Insurance_ Document. Details
Definition	A collection of data for a piece of written, printed or electronic matter that provides information or evidence.
Obj.ClassQual.	RV Request Insurance
Obj.ClassTerm	Document
Prop.TermQual.	
Prop.Term	
Repr.TermQual.	
Repr.Term	
Second.Repr.Term	
Assoc.Obj.ClassQual.	
Assoc.Obj.Class	
BusinessTerm(s)	



Qualified ABIE

## RV Request\_Change. Details

RV Request_Change. Details
RV Request_Change. Description. Text
RV Request_Change. Registration Plate_ Reason. Text
RV Request_Change. Vehicle License_ Reason. Text

### Documentation

Naziv	Registar Vozila Zahtjev Promjena
Opis	Podaci o/razlozi promjena vezano za registraciju vozila

### CCTS

Type	ABIE
Dict.EntryName	RV Request_Change. Details
Definition	An alternation or modification.
Obj.ClassQual.	RV Request
Obj.ClassTerm	Change
Prop.TermQual.	
Prop.Term	
Repr.TermQual.	
Repr.Term	
Second.Repr.Term	
Assoc.Obj.ClassQual.	
Assoc.Obj.Class	
BusinessTerm(s)	





Qualified ABIE

## RV Request\_ Document. Details

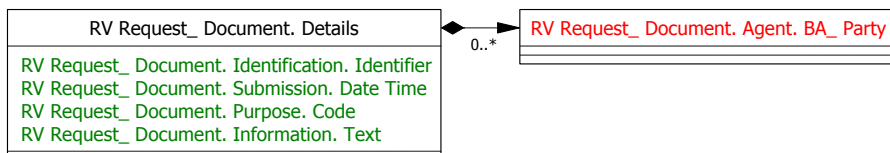

### Documentation

Naziv	Registar Vozila Zahtjev Dokument
Opis	Dokument zahtjeva za registraciju vozila

### CCTS

Type	ABIE
Dict.EntryName	RV Request_ Document. Details
Definition	A collection of data for a piece of written, printed or electronic matter that provides information or evidence.
Obj.ClassQual.	RV Request
Obj.ClassTerm	Document
Prop.TermQual.	
Prop.Term	
Repr.TermQual.	
Repr.Term	
Second.Repr.Term	
Assoc.Obj.ClassQual.	
Assoc.Obj.Class	
BusinessTerm(s)	



Qualified ABIE

## RV Request\_ Product. Details

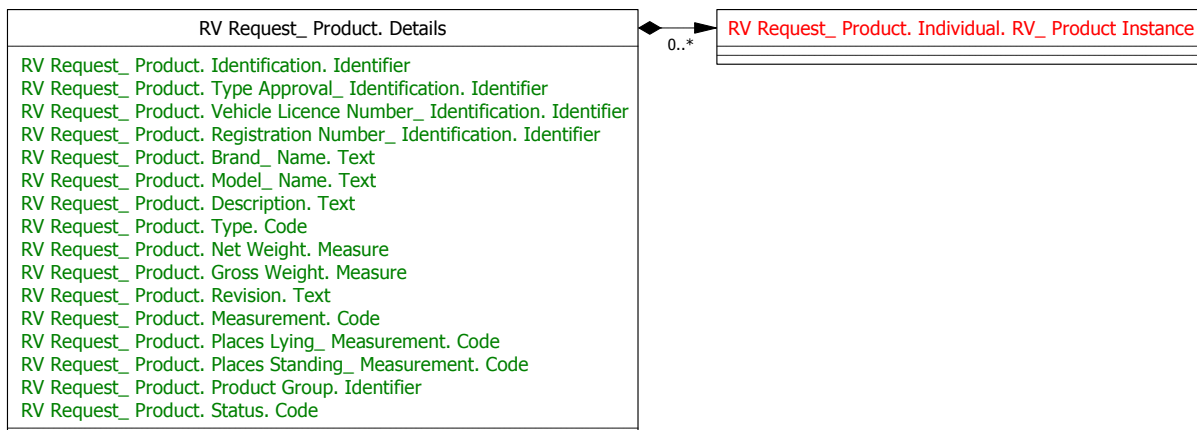

### Documentation

Naziv	Registar Vozila Zahtjev Proizvod
Opis	Skup podataka o vozilu

### CCTS

Type	ABIE
Dict.EntryName	RV Request_ Product. Details
Definition	Any tangible output or service produced by human or mechanical effort or by a natural process.
Obj.ClassQual.	RV Request
Obj.ClassTerm	Product
Prop.TermQual.	
Prop.Term	
Repr.TermQual.	
Repr.Term	
Second.Repr.Term	
Assoc.Obj.ClassQual.	
Assoc.Obj.Class	
BusinessTerm(s)	



Qualified ABIE

## RV Request\_ Registration. Details

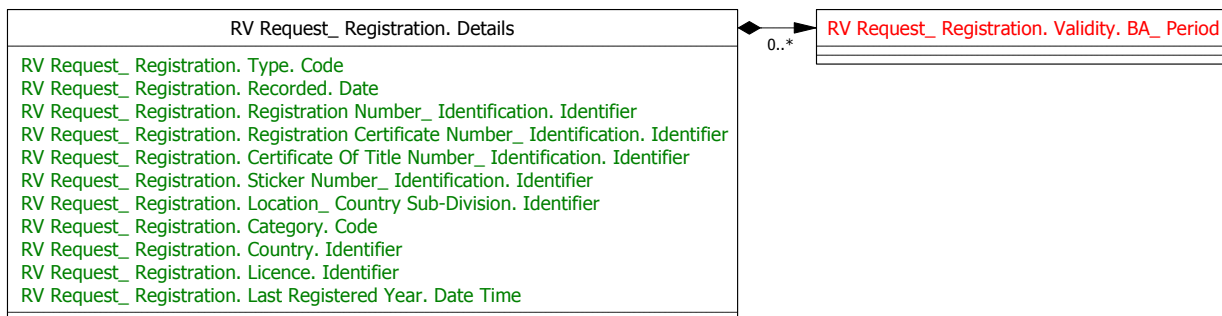

### Documentation

Naziv	Registar Vozila Zahtjev Registracija
Opis	Podaci o registraciji vozila

### CCTS

Type	ABIE
Dict.EntryName	RV Request_ Registration. Details
Definition	The recording of items or details for a specific purpose.
Obj.ClassQual.	RV Request
Obj.ClassTerm	Registration
Prop.TermQual.	
Prop.Term	
Repr.TermQual.	
Repr.Term	
Second.Repr.Term	
Assoc.Obj.ClassQual.	
Assoc.Obj.Class	
BusinessTerm(s)	



Qualified ABIE

## RV\_ Colour. Details

RV_ Colour. Details
RV_ Colour. Actual Colour. Code
RV_ Colour. Description. Text

### Documentation

Naziv	Boja
Opis	Podaci o boji

### CCTS

Type	ABIE
Dict.EntryName	RV_ Colour. Details
Definition	The property possessed by an object of producing different sensations on the eye as a result of the way it reflects or emits light.
Obj.ClassQual.	RV
Obj.ClassTerm	Colour
Prop.TermQual.	
Prop.Term	
Repr.TermQual.	
Repr.Term	
Second.Repr.Term	
Assoc.Obj.ClassQual.	
Assoc.Obj.Class	
BusinessTerm(s)	



Qualified ABIE

## RV\_Engine. Details

RV_Engine. Details
RV_Engine. Type. Code
RV_Engine. ECO_ Type. Code
RV_Engine. Catalyst_ Type. Code
RV_Engine. Serial Number. Identifier
RV_Engine. Fuel Type. Code
RV_Engine. Power. Measure
RV_Engine. Weight Ratio_ Power. Measure
RV_Engine. Cubic Capacity. Measure
RV_Engine. Cylinder. Quantity
RV_Engine. Turbo. Indicator

### Documentation

Naziv	Motor
Opis	Podaci o motoru

### CCTS

Type	ABIE
Dict.EntryName	RV_Engine. Details
Definition	A machine with moving parts that converts power into motion.
Obj.ClassQual.	RV
Obj.ClassTerm	Engine
Prop.TermQual.	
Prop.Term	
Repr.TermQual.	
Repr.Term	
Second.Repr.Term	
Assoc.Obj.ClassQual.	
Assoc.Obj.Class	
BusinessTerm(s)	



Qualified ABIE

## RV\_ Product Instance. Details

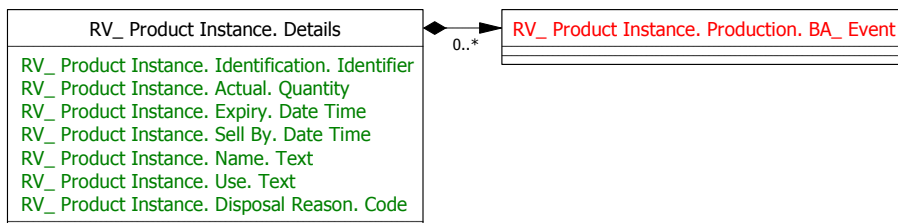

### Documentation

Naziv	Proizvod Instanca
Opis	Skup podataka o instanci proizvoda

### CCTS

Type	ABIE
Dict.EntryName	RV_ Product Instance. Details
Definition	An instance of an individual product or batch of similar products produced by human or mechanical effort or by a natural process.
Obj.ClassQual.	RV
Obj.ClassTerm	Product Instance
Prop.TermQual.	
Prop.Term	
Repr.TermQual.	
Repr.Term	
Second.Repr.Term	
Assoc.Obj.ClassQual.	
Assoc.Obj.Class	
BusinessTerm(s)	



Qualified ABIE

## RV\_ Vehicle. Details

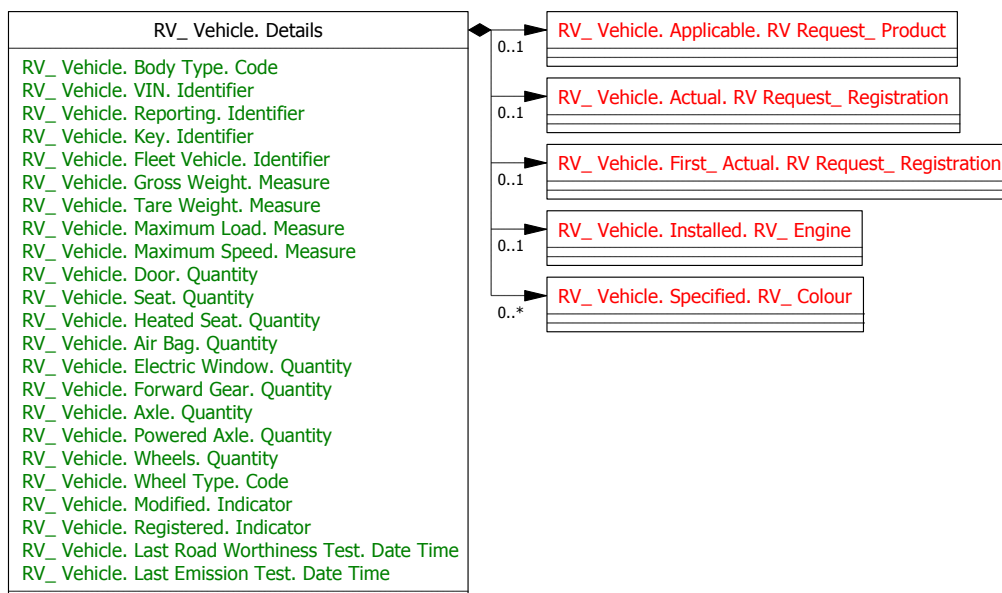

### Documentation

Naziv	Vozilo
Opis	Skupo podataka o vozilu

### CCTS

Type	ABIE
Dict.EntryName	RV_ Vehicle. Details
Definition	A means of conveyance, usually with wheels, for transporting people or goods, primarily on roads.
Obj.ClassQual.	RV
Obj.ClassTerm	Vehicle
Prop.TermQual.	
Prop.Term	
Repr.TermQual.	
Repr.Term	
Second.Repr.Term	



PROJEKT  
IZRADA I USPOSTAVLJANJE OKVIRA INTEROPERABILNOSTI I  
STANDARDA ZA RAZMJENU PODATAKA  
**INICIJALNI RJEČNIK PODATAKA**

Oznaka:  
PARCO-IFBIH

Page: 72 of 124

Assoc.Obj.ClassQual.	
Assoc.Obj.Class	
BusinessTerm(s)	





Qualified ABIE

## Citizenship Certificate\_ Document. Details

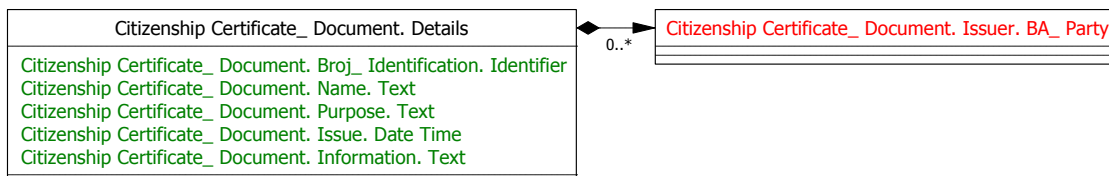

### Documentation

Naziv	Državljanstvo Certifikat Dokument
Opis	Dokument certifikata o državljanstvu

### CCTS

Type	ABIE
Dict.EntryName	Citizenship Certificate_ Document. Details
Definition	A collection of data for a piece of written, printed or electronic matter that provides information or evidence.
Obj.ClassQual.	Citizenship Certificate
Obj.ClassTerm	Document
Prop.TermQual.	
Prop.Term	
Repr.TermQual.	
Repr.Term	
Second.Repr.Term	
Assoc.Obj.ClassQual.	
Assoc.Obj.Class	
BusinessTerm(s)	



Qualified ABIE

## Citizenship Certificate\_ Person. Details

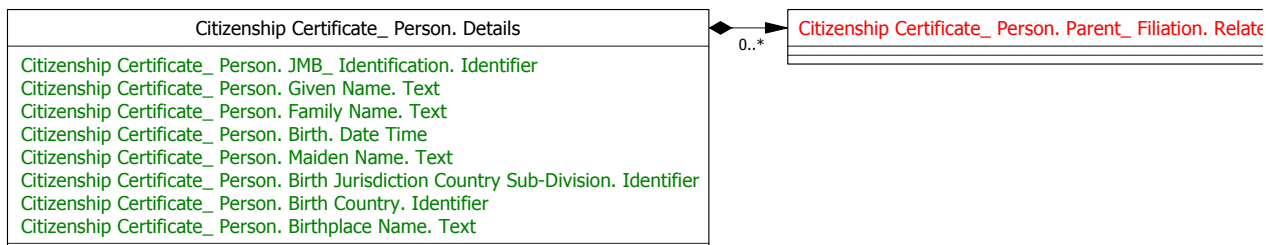

### Documentation

Naziv	Državljanstvo Certifikat Lice
Opis	Podaci o licu

### CCTS

Type	ABIE
Dict.EntryName	Citizenship Certificate_ Person. Details
Definition	An individual human being.
Obj.ClassQual.	Citizenship Certificate
Obj.ClassTerm	Person
Prop.TermQual.	
Prop.Term	
Repr.TermQual.	
Repr.Term	
Second.Repr.Term	
Assoc.Obj.ClassQual.	
Assoc.Obj.Class	
BusinessTerm(s)	



Qualified ABIE

## MO Registration\_ Document. Details

MO Registration_ Document. Details
MO Registration_ Document. Identification. Identifier
MO Registration_ Document. Broj_ Identification. Identifier
MO Registration_ Document. Submission. Date Time
MO Registration_ Document. Acceptance. Date Time
MO Registration_ Document. Base_ Information. Text
MO Registration_ Document. Accepted By_ Information. Text
MO Registration_ Document. Entered By_ Information. Text
MO Registration_ Document. Submission Location_ Information. Text

### Documentation

Naziv	Penziono osiguranje Registracija
Opis	Dokument za registraciju za penziono osiguranje

### CCTS

Type	ABIE
Dict.EntryName	MO Registration_ Document. Details
Definition	A collection of data for a piece of written, printed or electronic matter that provides information or evidence.
Obj.ClassQual.	MO Registration
Obj.ClassTerm	Document
Prop.TermQual.	
Prop.Term	
Repr.TermQual.	
Repr.Term	
Second.Repr.Term	
Assoc.Obj.ClassQual.	
Assoc.Obj.Class	
BusinessTerm(s)	



Qualified ABIE

## MO\_ Organization. Details

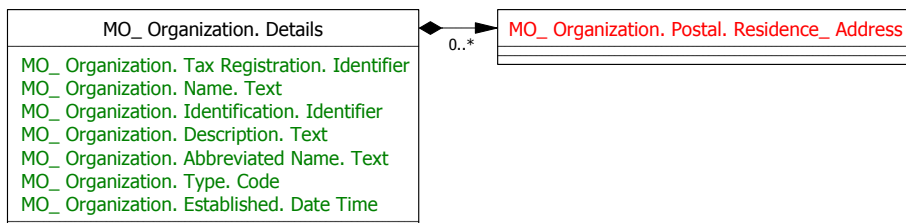

### Documentation

Naziv	Penziono Osiguranje Organizacija
Opis	Podaci o organizaciji za penziono osiguranje

### CCTS

Type	ABIE
Dict.EntryName	MO_ Organization. Details
Definition	An organized structure set up for a particular purpose, such as a business, government body, department, charity, or financial institution.
Obj.ClassQual.	MO
Obj.ClassTerm	Organization
Prop.TermQual.	
Prop.Term	
Repr.TermQual.	
Repr.Term	
Second.Repr.Term	
Assoc.Obj.ClassQual.	
Assoc.Obj.Class	
BusinessTerm(s)	



Qualified ABIE

## MO\_ Person. Details

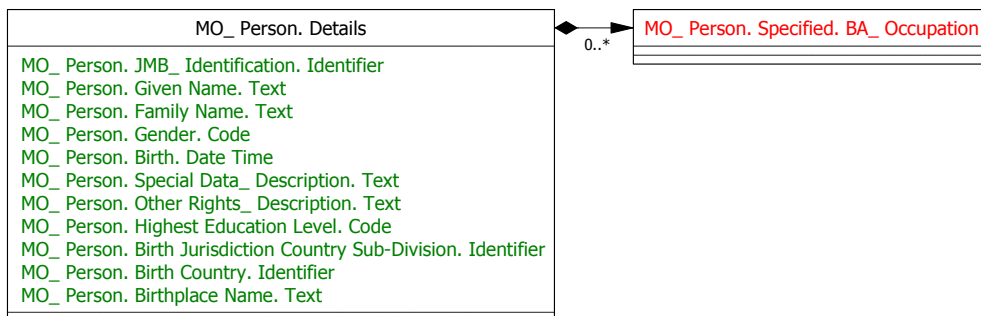

### Documentation

Naziv	Penziono Osiguranje lica
Opis	Podaci o licu za penziono osiuranje

### CCTS

Type	ABIE
Dict.EntryName	MO_ Person. Details
Definition	An individual human being.
Obj.ClassQual.	MO
Obj.ClassTerm	Person
Prop.TermQual.	
Prop.Term	
Repr.TermQual.	
Repr.Term	
Second.Repr.Term	
Assoc.Obj.ClassQual.	
Assoc.Obj.Class	
BusinessTerm(s)	



Qualified ABIE

## MO\_ Registration. Details

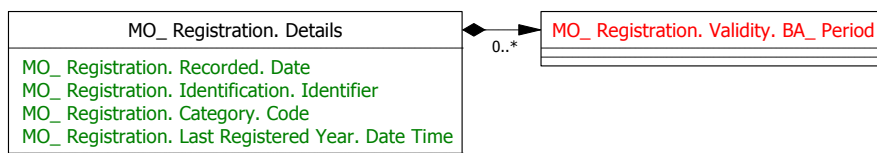

### Documentation

Naziv	Penziono Osiguranje Registracija
Opis	Podaci o registraciji za penziono osiguranje

### CCTS

Type	ABIE
Dict.EntryName	MO_Registration.Details
Definition	The recording of items or details for a specific purpose.
Obj.ClassQual.	MO
Obj.ClassTerm	Registration
Prop.TermQual.	
Prop.Term	
Repr.TermQual.	
Repr.Term	
Second.Repr.Term	
Assoc.Obj.ClassQual.	
Assoc.Obj.Class	
BusinessTerm(s)	



Qualified ABIE

## ZD Registration\_ Document. Details

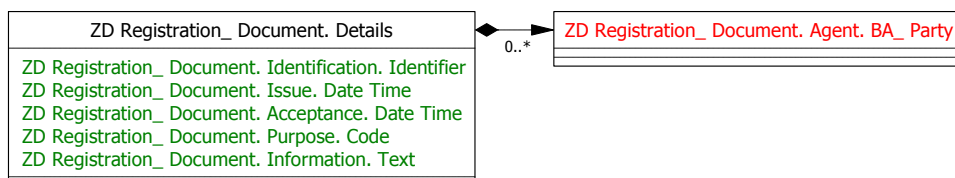

### Documentation

Naziv	Zdravstveno Osiguranje Registracija Dokument
Opis	Dokument za registraciju za zdravstveno osiguranje

### CCTS

Type	ABIE
Dict.EntryName	ZD Registration_ Document. Details
Definition	A collection of data for a piece of written, printed or electronic matter that provides information or evidence.
Obj.ClassQual.	ZD Registration
Obj.ClassTerm	Document
Prop.TermQual.	
Prop.Term	
Repr.TermQual.	
Repr.Term	
Second.Repr.Term	
Assoc.Obj.ClassQual.	
Assoc.Obj.Class	
BusinessTerm(s)	



Qualified ABIE

## ZD Registration\_ Organization. Details

ZD Registration_ Organization. Details
ZD Registration_ Organization. Tax Registration. Identifier
ZD Registration_ Organization. Name. Text
ZD Registration_ Organization. Identification. Identifier
ZD Registration_ Organization. Description. Text
ZD Registration_ Organization. Abbreviated Name. Text
ZD Registration_ Organization. Type. Code
ZD Registration_ Organization. Established. Date Time
ZD Registration_ Organization. Division Name. Text

### Documentation

Naziv	Zdravstveno Osiguranje Registracija Organizacija
Opis	Podaci o organizaciji za registraciju zdravstvenog osiguranja

### CCTS

Type	ABIE
Dict.EntryName	ZD Registration_ Organization. Details
Definition	An organized structure set up for a particular purpose, such as a business, government body, department, charity, or financial institution.
Obj.ClassQual.	ZD Registration
Obj.ClassTerm	Organization
Prop.TermQual.	
Prop.Term	
Repr.TermQual.	
Repr.Term	
Second.Repr.Term	
Assoc.Obj.ClassQual.	
Assoc.Obj.Class	
BusinessTerm(s)	





Qualified ABIE

## ZD Registration\_ Person. Details

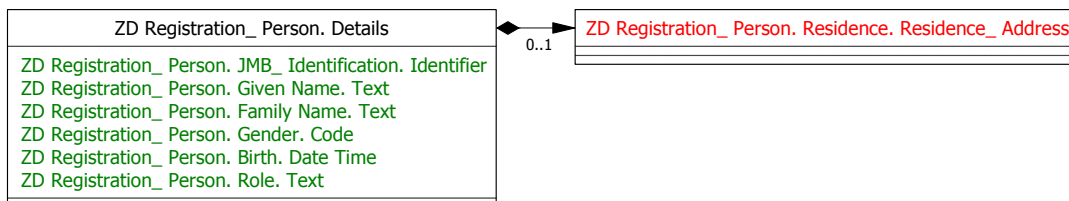

### Documentation

Naziv	Zdravstveno Osiguranje Registracija Lice
Opis	Podaci o licu za registraciju zdravstvenog osiguranja

### CCTS

Type	ABIE
Dict.EntryName	ZD Registration_ Person. Details
Definition	An individual human being.
Obj.ClassQual.	ZD Registration
Obj.ClassTerm	Person
Prop.TermQual.	
Prop.Term	
Repr.TermQual.	
Repr.Term	
Second.Repr.Term	
Assoc.Obj.ClassQual.	
Assoc.Obj.Class	
BusinessTerm(s)	



Qualified ABIE

## ZD\_ Registration. Details



### Documentation

Naziv	Registracija
Opis	Skup podataka o registraciji

### CCTS

Type	ABIE
Dict.EntryName	ZD_Registration. Details
Definition	The recording of items or details for a specific purpose.
Obj.ClassQual.	ZD
Obj.ClassTerm	Registration
Prop.TermQual.	
Prop.Term	
Repr.TermQual.	
Repr.Term	
Second.Repr.Term	
Assoc.Obj.ClassQual.	
Assoc.Obj.Class	
BusinessTerm(s)	



Qualified ABIE

## Clearance\_ Document. Details

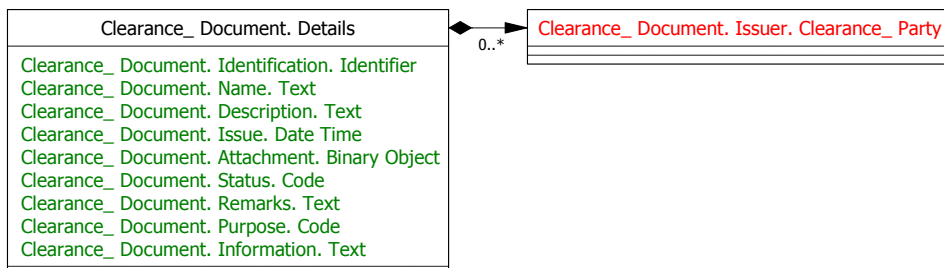

### Documentation

Naziv	Uvjerenje Potvrda Dokument
Opis	Dokument uvjerenja ili potvrde

### CCTS

Type	ABIE
Dict.EntryName	Clearance_ Document. Details
Definition	A collection of data for a piece of written, printed or electronic matter that provides information or evidence.
Obj.ClassQual.	Clearance
Obj.ClassTerm	Document
Prop.TermQual.	
Prop.Term	
Repr.TermQual.	
Repr.Term	
Second.Repr.Term	
Assoc.Obj.ClassQual.	
Assoc.Obj.Class	
BusinessTerm(s)	



Qualified ABIE

## Clearance\_Party. Details

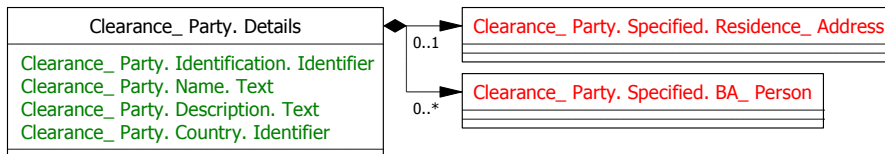

### Documentation

Naziv	Uvjerenje Potvrda Strana
Opis	Podaci o strani u potvrdi ili uvjerenju.

### CCTS

Type	ABIE
Dict.EntryName	Clearance_Party. Details
Definition	An individual, a group, or a body having a role in a business function. Party has a legal connotation in a business transaction.
Obj.ClassQual.	Clearance
Obj.ClassTerm	Party
Prop.TermQual.	
Prop.Term	
Repr.TermQual.	
Repr.Term	
Second.Repr.Term	
Assoc.Obj.ClassQual.	
Assoc.Obj.Class	
BusinessTerm(s)	



Qualified ABIE

## BA\_ Classification Item. Details

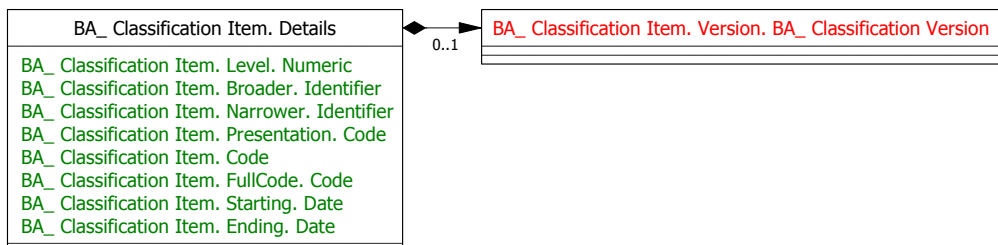

### Documentation

Naziv	Klasifikacija Stavka
Opis	Stavka u klasifikaciji.

### CCTS

Type	ABIE
Dict.EntryName	BA_ Classification Item. Details
Definition	
Obj.ClassQual.	BA
Obj.ClassTerm	Classification Item
Prop.TermQual.	
Prop.Term	
Repr.TermQual.	
Repr.Term	
Second.Repr.Term	
Assoc.Obj.ClassQual.	
Assoc.Obj.Class	
BusinessTerm(s)	



Qualified ABIE

## BA\_ Classification Version. Details

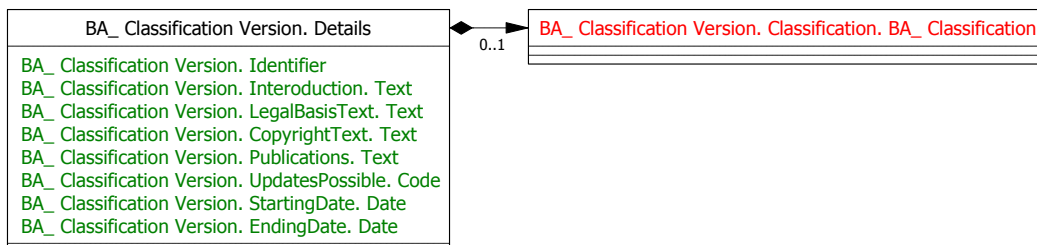

### Documentation

Naziv	Klasifikacija Verzija
Opis	Verzija Klasifikacije

### CCTS

Type	ABIE
Dict.EntryName	BA_ Classification Version. Details
Definition	
Obj.ClassQual.	BA
Obj.ClassTerm	Classification Version
Prop.TermQual.	
Prop.Term	
Repr.TermQual.	
Repr.Term	
Second.Repr.Term	
Assoc.Obj.ClassQual.	
Assoc.Obj.Class	
BusinessTerm(s)	



Qualified ABIE

## BA\_ Classification. Details

BA_ Classification. Details
BA_ Classification. Identifier
BA_ Classification. Owner. Text
BA_ Classification. UpdatePolicy. Text
BA_ Classification. ObjectsClassified. Text

### Documentation

Naziv	Klasifikacija
Opis	Klasifikacioni sistem

### CCTS

Type	ABIE
Dict.EntryName	BA_ Classification. Details
Definition	
Obj.ClassQual.	BA
Obj.ClassTerm	Classification
Prop.TermQual.	
Prop.Term	
Repr.TermQual.	
Repr.Term	
Second.Repr.Term	
Assoc.Obj.ClassQual.	
Assoc.Obj.Class	
BusinessTerm(s)	



Qualified ABIE

## BA Envelope\_ Document. Details

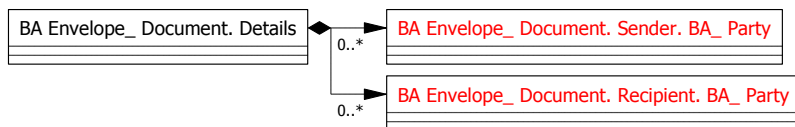

### Documentation

Naziv	Dokument Ovojnica
Opis	Ovojnica dokumenta

### CCTS

Type	ABIE
Dict.EntryName	BA Envelope_ Document. Details
Definition	A collection of data for a piece of written, printed or electronic matter that provides information or evidence.
Obj.ClassQual.	BA Envelope
Obj.ClassTerm	Document
Prop.TermQual.	
Prop.Term	
Repr.TermQual.	
Repr.Term	
Second.Repr.Term	
Assoc.Obj.ClassQual.	
Assoc.Obj.Class	
BusinessTerm(s)	





Qualified ABIE

## BA Generic\_ Document. Details

BA Generic_ Document. Details
BA Generic_ Document. Identification. Identifier
BA Generic_ Document. Type. Code
BA Generic_ Document. Name. Text
BA Generic_ Document. Description. Text
BA Generic_ Document. Issue. Date Time
BA Generic_ Document. Submission. Date Time
BA Generic_ Document. Receipt. Date Time
BA Generic_ Document. Attachment. Binary Object
BA Generic_ Document. Creation. Date Time
BA Generic_ Document. Status. Code
BA Generic_ Document. Copy. Indicator
BA Generic_ Document. Response. Date Time
BA Generic_ Document. Remarks. Text
BA Generic_ Document. Language. Identifier
BA Generic_ Document. Currency. Code
BA Generic_ Document. Line Count. Numeric
BA Generic_ Document. Line. Identifier
BA Generic_ Document. Line Status. Code
BA Generic_ Document. Multiple References. Indicator
BA Generic_ Document. Revision. Text
BA Generic_ Document. Authorization. Text
BA Generic_ Document. Checksum. Numeric
BA Generic_ Document. Processing Type. Code
BA Generic_ Document. Item. Quantity
BA Generic_ Document. Acceptance. Date Time
BA Generic_ Document. Purpose. Code
BA Generic_ Document. Information. Text

### Documentation

Naziv	Dokument Genericki
Opis	Generički dokument

### CCTS

Type	ABIE
Dict.EntryName	BA Generic_ Document. Details
Definition	A collection of data for a piece of written, printed or electronic matter that provides information or evidence.
Obj.ClassQual.	BA Generic
Obj.ClassTerm	Document
Prop.TermQual.	
Prop.Term	
Repr.TermQual.	
Repr.Term	
Second.Repr.Term	



PROJEKT  
IZRADA I USPOSTAVLJANJE OKVIRA INTEROPERABILNOSTI I  
STANDARDA ZA RAZMJENU PODATAKA  
**INICIJALNI RJEČNIK PODATAKA**

Oznaka:  
PARCO-IFBIH

Page: 90 of 124

Assoc.Obj.ClassQual.	
Assoc.Obj.Class	
BusinessTerm(s)	



Qualified ABIE

## BA Excerpt\_ Document. Details

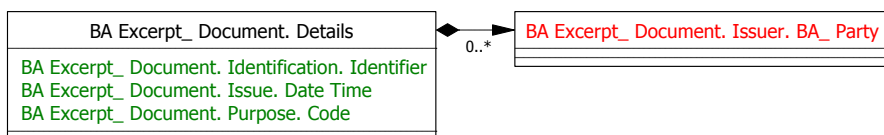

### Documentation

Naziv	Izvadak Dokument
Opis	Izvadak dokumenta iz evidencije

### CCTS

Type	ABIE
Dict.EntryName	BA Excerpt_ Document. Details
Definition	A collection of data for a piece of written, printed or electronic matter that provides information or evidence.
Obj.ClassQual.	BA Excerpt
Obj.ClassTerm	Document
Prop.TermQual.	
Prop.Term	
Repr.TermQual.	
Repr.Term	
Second.Repr.Term	
Assoc.Obj.ClassQual.	
Assoc.Obj.Class	
BusinessTerm(s)	



Qualified ABIE

## BA\_ Address. Details

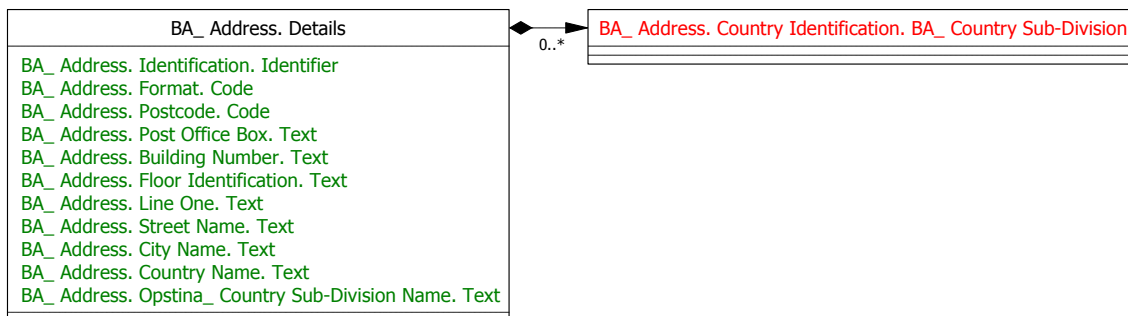

### Documentation

Naziv	Rezidencijalna Adresa
Opis	Adresa prebivališta/boravišta

### CCTS

Type	ABIE
Dict.EntryName	BA_ Address. Details
Definition	The location at which a particular organization or person may be found or reached.
Obj.ClassQual.	BA
Obj.ClassTerm	Address
Prop.TermQual.	
Prop.Term	
Repr.TermQual.	
Repr.Term	
Second.Repr.Term	
Assoc.Obj.ClassQual.	
Assoc.Obj.Class	
BusinessTerm(s)	



Qualified ABIE

## BA\_ Binary File. Details

BA_ Binary File. Details
BA_ Binary File. Identification. Identifier
BA_ Binary File. Title. Text
BA_ Binary File. File Name. Text
BA_ Binary File. MIME. Code
BA_ Binary File. Included. Binary Object
BA_ Binary File. Description. Text

### Documentation

Naziv	Binarni File
Opis	Binarni file s pripadajućim podacima

### CCTS

Type	ABIE
Dict.EntryName	BA_ Binary File. Details
Definition	A computer file or program stored in a binary format.
Obj.ClassQual.	BA
Obj.ClassTerm	Binary File
Prop.TermQual.	
Prop.Term	
Repr.TermQual.	
Repr.Term	
Second.Repr.Term	
Assoc.Obj.ClassQual.	
Assoc.Obj.Class	
BusinessTerm(s)	



Qualified ABIE

## BA\_ Country Sub-Division. Details

BA_ Country Sub-Division. Details
BA_ Country Sub-Division. Identification. Identifier
BA_ Country Sub-Division. Name. Text
BA_ Country Sub-Division. Type. Code
BA_ Country Sub-Division. Description. Text
BA_ Country Sub-Division. Hierarchical Level. Code

### Documentation

Naziv	BA Država Podjedinica
Opis	Podaci o pod-jedinici države

### CCTS

Type	ABIE
Dict.EntryName	BA_ Country Sub-Division. Details
Definition	An area of land which is a sub-division within a country, such as a state, a county, a canton, a province, etc.
Obj.ClassQual.	BA
Obj.ClassTerm	Country Sub-Division
Prop.TermQual.	
Prop.Term	
Repr.TermQual.	
Repr.Term	
Second.Repr.Term	
Assoc.Obj.ClassQual.	
Assoc.Obj.Class	
BusinessTerm(s)	



Qualified ABIE

## BA\_ Document. Details

BA_ Document. Details
BA_ Document. Multiple Type. Indicator
BA_ Document. Identification. Identifier
BA_ Document. Type. Code
BA_ Document. Name. Text
BA_ Document. Purpose. Text
BA_ Document. Description. Text
BA_ Document. Issue. Date Time
BA_ Document. Submission. Date Time
BA_ Document. Receipt. Date Time
BA_ Document. Control Requirement. Indicator
BA_ Document. Attachment. Binary Object
BA_ Document. Creation. Date Time
BA_ Document. Status. Code
BA_ Document. Copy. Indicator
BA_ Document. Response. Date Time
BA_ Document. Remarks. Text
BA_ Document. Language. Identifier
BA_ Document. Currency. Code
BA_ Document. Line Count. Numeric
BA_ Document. Line. Identifier
BA_ Document. Line Status. Code
BA_ Document. Multiple References. Indicator
BA_ Document. Revision. Text
BA_ Document. Authorization. Text
BA_ Document. Checksum. Numeric
BA_ Document. Processing Type. Code
BA_ Document. Item. Quantity
BA_ Document. Acceptance. Date Time
BA_ Document. Original Required. Quantity
BA_ Document. Copy Required. Quantity
BA_ Document. Original Issued. Quantity
BA_ Document. Copy Issued. Quantity
BA_ Document. Purpose. Code
BA_ Document. Information. Text
BA_ Document. Relationship Type. Code
BA_ Document. Authenticated Original. Indicator
BA_ Document. Electronic Presentation. Indicator
BA_ Document. Page. Identifier
BA_ Document. Total Page. Quantity
BA_ Document. Category. Code
BA_ Document. Revision. Date Time
BA_ Document. Rejection Reason. Text
BA_ Document. Cancellation Reason. Code
BA_ Document. Cancellation. Date Time
BA_ Document. Sequence. Identifier

### Documentation

Naziv	Dokument
Opis	Dokument

CCTS



PROJEKT  
IZRADA I USPOSTAVLJANJE OKVIRA INTEROPERABILNOSTI I  
STANDARDA ZA RAZMJENU PODATAKA  
**INICIJALNI RJEČNIK PODATAKA**

Oznaka:  
PARCO-IFBIH

Page: 96 of 124

Type	ABIE
Dict.EntryName	BA_Document. Details
Definition	A collection of data for a piece of written, printed or electronic matter that provides information or evidence.
Obj.ClassQual.	BA
Obj.ClassTerm	Document
Prop.Term	
BusinessTerm(s)	





Qualified ABIE

## BA\_ Event. Details

BA_ Event. Details
BA_ Event. Identification. Identifier
BA_ Event. Occurrence. Date Time
BA_ Event. Type. Code
BA_ Event. Description. Text

### Documentation

Naziv	Događaj
Opis	Događaj

### CCTS

Type	ABIE
Dict.EntryName	BA_ Event. Details
Definition	A significant occurrence or happening related to an object process, or person.
Obj.ClassQual.	BA
Obj.ClassTerm	Event
Prop.TermQual.	
Prop.Term	
Repr.TermQual.	
Repr.Term	
Second.Repr.Term	
Assoc.Obj.ClassQual.	
Assoc.Obj.Class	
BusinessTerm(s)	

Qualified ABIE

## BA\_Location. Details

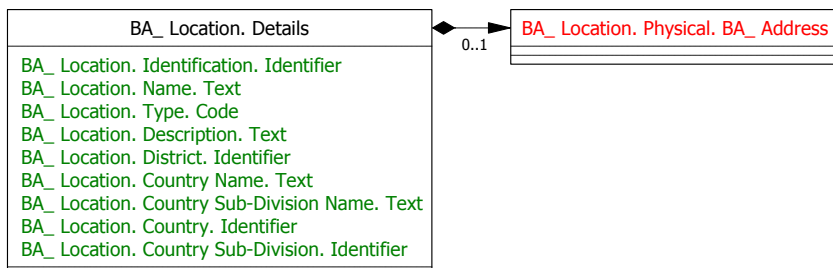

### Documentation

Naziv	BA Lokacija
Opis	Podaci o lokaciji

### CCTS

Type	ABIE
Dict.EntryName	BA_Location. Details
Definition	A physical location or place.
Obj.ClassQual.	BA
Obj.ClassTerm	Location
Prop.TermQual.	
Prop.Term	
Repr.TermQual.	
Repr.Term	
Second.Repr.Term	
Assoc.Obj.ClassQual.	
Assoc.Obj.Class	
BusinessTerm(s)	



Qualified ABIE

## BA\_ Occupation. Details

BA_ Occupation. Details
BA_ Occupation. Type. Code
BA_ Occupation. Description. Text
BA_ Occupation. Class. Code
BA_ Occupation. Ranking. Code
BA_ Occupation. Full-Time. Indicator

### Documentation

Naziv	BA Zanimanje
Opis	Podaci o zanimanju

### CCTS

Type	ABIE
Dict.EntryName	BA_ Occupation. Details
Definition	A person's job or profession.
Obj.ClassQual.	BA
Obj.ClassTerm	Occupation
Prop.TermQual.	
Prop.Term	
Repr.TermQual.	
Repr.Term	
Second.Repr.Term	
Assoc.Obj.ClassQual.	
Assoc.Obj.Class	
BusinessTerm(s)	



Qualified ABIE

## BA\_Party. Details

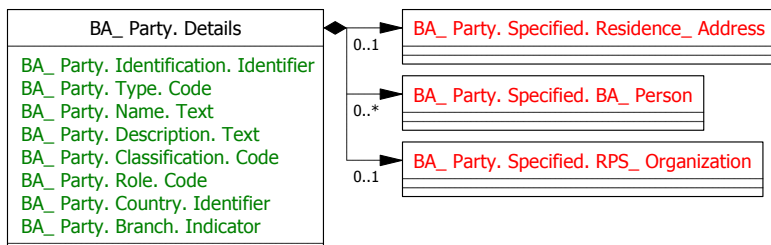

### Documentation

Naziv	BA Stranka
Opis	Podaci o stranki

### CCTS

Type	ABIE
Dict.EntryName	BA_Party. Details
Definition	An individual, a group, or a body having a role in a business function. Party has a legal connotation in a business transaction.
Obj.ClassQual.	BA
Obj.ClassTerm	Party
Prop.TermQual.	
Prop.Term	
Repr.TermQual.	
Repr.Term	
Second.Repr.Term	
Assoc.Obj.ClassQual.	
Assoc.Obj.Class	
BusinessTerm(s)	



Qualified ABIE

## BA\_Period. Details

BA_Period. Details
BA_Period. Duration. Measure
BA_Period. Description. Text
BA_Period. Start. Date Time
BA_Period. End. Date Time

### Documentation

Naziv	Lična Karta Period
Opis	Vremenski period koji se koristi u evidenciji ličnih karti

### CCTS

Type	ABIE
Dict.EntryName	BA_Period. Details
Definition	A specific period of time such as the length of time between two known date/time points, from a start date onwards, or up to an end date.
Obj.ClassQual.	BA
Obj.ClassTerm	Period
Prop.TermQual.	
Prop.Term	
Repr.TermQual.	
Repr.Term	
Second.Repr.Term	
Assoc.Obj.ClassQual.	
Assoc.Obj.Class	
BusinessTerm(s)	



Qualified ABIE

## BA\_Person. Details

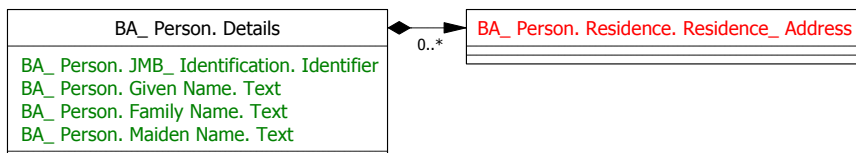

### Documentation

Naziv	BA Lice
Opis	Podaci o licu

### CCTS

Type	ABIE
Dict.EntryName	BA_Person. Details
Definition	An individual human being.
Obj.ClassQual.	BA
Obj.ClassTerm	Person
Prop.TermQual.	
Prop.Term	
Repr.TermQual.	
Repr.Term	
Second.Repr.Term	
Assoc.Obj.ClassQual.	
Assoc.Obj.Class	
BusinessTerm(s)	

Qualified ABIE

## BA\_ Signature. Details

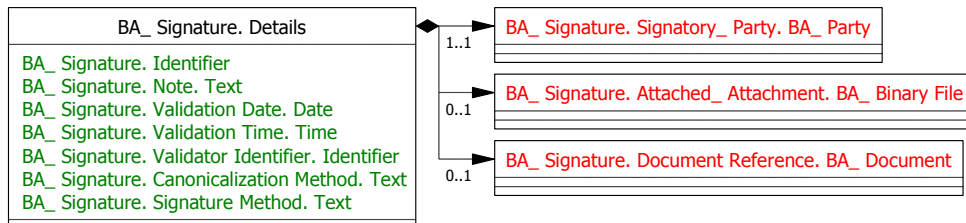

### Documentation

Naziv	Potpis
Opis	Potpis na dijelove dokumenta ili potpis kojim je potpisan dokument prije kreiranja

### CCTS

Type	ABIE
Dict.EntryName	BA_ Signature. Details
Definition	Information about signature. A placeholder for signature.
Obj.ClassQual.	BA
Obj.ClassTerm	Signature
Prop.TermQual.	
Prop.Term	
Repr.TermQual.	
Repr.Term	
Second.Repr.Term	
Assoc.Obj.ClassQual.	
Assoc.Obj.Class	
BusinessTerm(s)	



Qualified ABIE

## Photo\_ Binary File. Details

Photo_ Binary File. Details
Photo_ Binary File. Identification. Identifier
Photo_ Binary File. Title. Text
Photo_ Binary File. File Name. Text
Photo_ Binary File. MIME. Code
Photo_ Binary File. Included. Binary Object
Photo_ Binary File. Description. Text

### Documentation

Naziv	Fotografija file
Opis	Binarni file fotografija s pripadajućim podacima.

### CCTS

Type	ABIE
Dict.EntryName	Photo_ Binary File. Details
Definition	A computer file or program stored in a binary format.
Obj.ClassQual.	Photo
Obj.ClassTerm	Binary File
Prop.TermQual.	
Prop.Term	
Repr.TermQual.	
Repr.Term	
Second.Repr.Term	
Assoc.Obj.ClassQual.	
Assoc.Obj.Class	
BusinessTerm(s)	





Qualified ABIE

## Related\_Person. Details

Related_Person. Details
Related_Person. Given Name. Text
Related_Person. Family Name. Text
Related_Person. Maiden Name. Text

### Documentation

Naziv	Povezano Lice
Opis	Podaci o povezanom licu/ licu u srodstvu

### CCTS

Type	ABIE
Dict.EntryName	Related_Person. Details
Definition	An individual human being.
Obj.ClassQual.	Related
Obj.ClassTerm	Person
Prop.TermQual.	
Prop.Term	
Repr.TermQual.	
Repr.Term	
Second.Repr.Term	
Assoc.Obj.ClassQual.	
Assoc.Obj.Class	
BusinessTerm(s)	



Qualified ABIE

## Request\_Country. Details

Request_Country. Details
Request_Country. Name. Text

### Documentation

Naziv	Zahtjev Država
Opis	Podaci o državi koji se koriste u zahtjevu

### CCTS

Type	ABIE
Dict.EntryName	Request_Country. Details
Definition	The area of land that belongs to a nation together with its properties such as population, political organization, etc.
Obj.ClassQual.	Request
Obj.ClassTerm	Country
Prop.TermQual.	
Prop.Term	
Repr.TermQual.	
Repr.Term	
Second.Repr.Term	
Assoc.Obj.ClassQual.	
Assoc.Obj.Class	
BusinessTerm(s)	



Qualified ABIE

## Residence\_ Address. Details

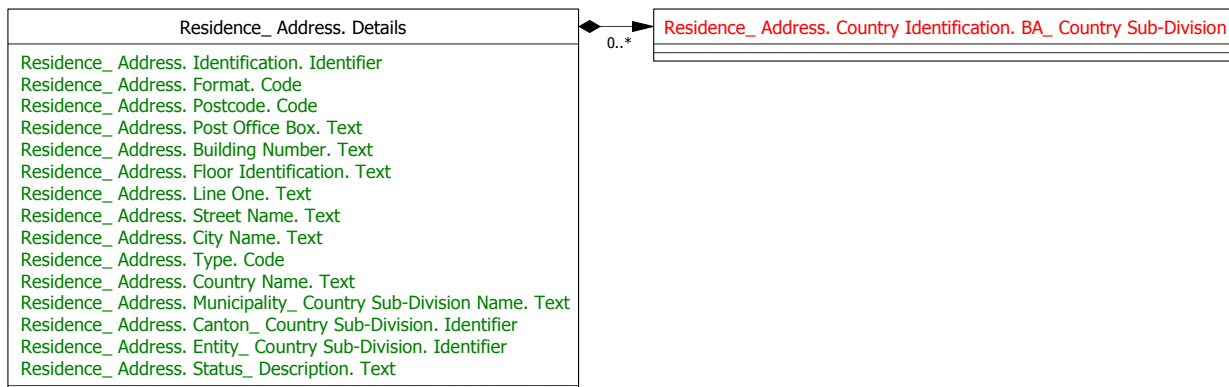

### Documentation

Naziv	Rezidencijalna Adresa
Opis	Adresa prebivališta/boravišta

### CCTS

Type	ABIE
Dict.EntryName	Residence_ Address. Details
Definition	The location at which a particular organization or person may be found or reached.
Obj.ClassQual.	Residence
Obj.ClassTerm	Address
Prop.TermQual.	
Prop.Term	
Repr.TermQual.	
Repr.Term	
Second.Repr.Term	
Assoc.Obj.ClassQual.	
Assoc.Obj.Class	
BusinessTerm(s)	



## 5. DOKUMENTI XML

U ovom su poglavlju prikazane XML datoteke za odabrane poslovne dokumente iz poglavlja 3

### Zahtjev za izdavanje Jedinstvenog matičnog broja

```
<?xml version="1.0" encoding="UTF-8"?>
<!--Sample XML file generated by XMLSpy v2009 (http://www.altova.com)-->
<documentsram:JMBRequest
xsi:schemaLocation="urn:ReusableAggregateBusinessInformationEntity:1 JMBRequest.xsd"
xmlns:xsi="http://www.w3.org/2001/XMLSchema-instance"
xmlns:documentsram="urn:ReusableAggregateBusinessInformationEntity:1"
xmlns:ram="urn:un:unece:uncefact:data:standard:ReusableAggregateBusinessInformationEntity:7">
  <documentsram:DocumentJMBRequestDocument>
    <ram:ID>5451/3123-66-123</ram:ID>
    <ram:SubmissionDateTime>2012-09-27T00:00:00</ram:SubmissionDateTime>
    <ram:PurposeCode>Obavještenje/Zahtjev(Postupak)</ram:PurposeCode>
    <ram:ReferenceJMBRequestMKRDocument>
      <ram:ID>384</ram:ID>
      <ram:CreationDateTime>1975-09-27T00:00:00</ram:CreationDateTime>
      <ram:PageID>467</ram:PageID>
      <ram:IssueMKRLocation>
        <ram:Name>SARAJEVO</ram:Name>
      </ram:IssueMKRLocation>
    </ram:ReferenceJMBRequestMKRDocument>
    <ram:RecipientBAParty>
      <ram:Name>Nadležni organ</ram:Name>
    </ram:RecipientBAParty>
    <ram:AgentBAParty>
      <ram:Name>Matični ured </ram:Name>
      <ram:SpecifiedBAPerson>
        <ram:GivenName>Vahida</ram:GivenName>
        <ram:FamilyName>Salihić</ram:FamilyName>
      </ram:SpecifiedBAPerson>
    </ram:AgentBAParty>
  </documentsram:DocumentJMBRequestDocument>
  <documentsram:PersonJMBRequestPerson>
    <ram:PreviousJMBID>//</ram:PreviousJMBID>
    <ram:GivenName languageCode="en-us">Maja</ram:GivenName>
    <ram:FamilyName languageCode="en-us">Malešić</ram:FamilyName>
    <ram:GenderCode>Z</ram:GenderCode>
    <ram:MunicipalityBirthJurisdictionCountrySubDivisionID>NOVO
SARAJEVO</ram:MunicipalityBirthJurisdictionCountrySubDivisionID>
    <ram:BirthCountryID>BIH</ram:BirthCountryID>
    <ram:BirthplaceName>SARAJEVO</ram:BirthplaceName>
    <ram:ResidenceJMBRequestAddress>
      <ram:PostcodeCode>12123231</ram:PostcodeCode>
      <ram:BuildingNumber>141</ram:BuildingNumber>
      <ram:StreetName>NOVOPA</ram:StreetName>
      <ram:CityName>SARAJEVO</ram:CityName>
      <ram:OpstinaCountrySubDivisionName>NOVO
SARAJEVO</ram:OpstinaCountrySubDivisionName>
    <ram:EntitetCountrySubDivisionName>FBIH</ram:EntitetCountrySubDivisionName>
```



```
<ram:KantonCountrySubDivisionName>SARAJEVO</ram:KantonCountrySubDivisionName>
  </ram:ResidenceJMBRequestAddress>
  <ram:NationalityRequestCountry>
    <ram:Name>BIH</ram:Name>
  </ram:NationalityRequestCountry>
  <ram:FiliationRelatedPerson>
    <ram:GivenName>Marijan</ram:GivenName>
    <ram:FamilyName>Malešić</ram:FamilyName>
  </ram:FiliationRelatedPerson>
  <ram:ChangeGenderCode>/</ram:ChangeGenderCode>
  <ram:BirthDateTime>2012-09-19T00:00:00</ram:BirthDateTime>
  <ram:MaidenName>///</ram:MaidenName>
</documentsram:PersonJMBRequestPerson>
</documentsram:JMBRequest>
```

## Zahtjev za izdavanje Lične karte

```
<?xml version="1.0" encoding="UTF-8"?>
<!--Sample XML file generated by XMLSpy v2009 (http://www.altova.com)-->
<userram:LKRequest xsi:schemaLocation="urn:ReusableAggregateBusinessInformationEntity:1
LKRequest.xsd" xmlns:xsi="http://www.w3.org/2001/XMLSchema-instance"
xmlns:userram="urn:ReusableAggregateBusinessInformationEntity:1"
xmlns:ram="urn:un:uncece:uncefact:data:standard:ReusableAggregateBusinessInformationEntity:7">
  <userram:DocumentLKRequestDocument>
    <ram:ID>1-468-04</ram:ID>
    <ram:NumRegID>2435436</ram:NumRegID>
    <ram:SubmissionDateTime>2012-09-28T00:00:00</ram:SubmissionDateTime>
    <ram:PurposeCode>Izdavanje LK</ram:PurposeCode>
    <ram:AttachmentsInformation>-</ram:AttachmentsInformation>
    <ram:AgentBAParty>
      <ram:Name>MUP KS, </ram:Name>
      <ram:SpecifiedResidenceAddress>
        <ram:CityName>SARAJEVO</ram:CityName>
        <ram:MunicipalityCountrySubDivisionName>STARI
GRAD</ram:MunicipalityCountrySubDivisionName>
      </ram:SpecifiedResidenceAddress>
    </ram:AgentBAParty>
    <ram:ReferenceLKPreviousDocument>
      <ram:RegNumID>//</ram:RegNumID>
      <ram:IssueDateTime>2012-09-05T00:00:00</ram:IssueDateTime>
      <ram:Information>//</ram:Information>
      <ram:IssueBALocation>
        <ram:Name>//</ram:Name>
      </ram:IssueBALocation>
    </ram:ReferenceLKPreviousDocument>
  </userram:DocumentLKRequestDocument>
  <userram:PersonLKRequestPerson>
    <ram:JMBID>251009651231414</ram:JMBID>
    <ram:GivenName>Biserka</ram:GivenName>
    <ram:FamilyName>Biserić</ram:FamilyName>
    <ram:GenderCode>ŽENSKI</ram:GenderCode>
    <ram:BirthDateTime>1965-10-25T00:00:00</ram:BirthDateTime>
    <ram:BirthplaceName>SARAJEVO</ram:BirthplaceName>
    <ram:ResidenceLKRequestAddress>
```



```
<ram:PostcodeCode>XXXXXXXX</ram:PostcodeCode>
<ram:BuildingNumber>5</ram:BuildingNumber>
<ram:StreetName>MLINI</ram:StreetName>
<ram:PrebivalisteCountryIdentificationBACountrySubDivision>
  <ram:Name>SARAJEVO STARI GRAD</ram:Name>
</ram:PrebivalisteCountryIdentificationBACountrySubDivision>
<ram: BoravisteCountryIdentificationBACountrySubDivision>
  <ram:Name/>
</ram: BoravisteCountryIdentificationBACountrySubDivision>
</ram:ResidenceLKRequestAddress>
<ram:NationalityRequestCountry>
  <ram:Name>BOSNA I HERCEGOVINA</ram:Name>
</ram:NationalityRequestCountry>
<ram:FiliationRelatedPerson>
  <ram:GivenName>Biso</ram:GivenName>
  <ram:FamilyName>Biserić</ram:FamilyName>
</ram:FiliationRelatedPerson>
</userram:PersonLKRequestPerson>
<userram:ChangeLKPreviousChange>
  <ram:Description>///</ram:Description>
  <ram:Reason>//</ram:Reason>
</userram:ChangeLKPreviousChange>
</userram:LKRequest>
```

## Zahtjev za registraciju vozila

```
<?xml version="1.0" encoding="UTF-8"?>
<!--Sample XML file generated by XMLSpy v2009 (http://www.altova.com)-->
<?xml-stylesheet type="text/xsl" href="RVRequest.xslt"?>
<documentsram:RVRequest
xsi:schemaLocation="urn:ReusableAggregateBusinessInformationEntity:1 RVRequest.xsd"
xmlns:xsi="http://www.w3.org/2001/XMLSchema-instance"
xmlns:documentsram="urn:ReusableAggregateBusinessInformationEntity:1"
xmlns:ram="urn:un:uncece:uncefact:data:standard:ReusableAggregateBusinessInformationEntity:7">
  <documentsram:DocumentRVRequestDocument>
    <ram:ID>123/123-55-123</ram:ID>
    <ram:SubmissionDateTime>2012-10-02T00:00:00</ram:SubmissionDateTime>
    <ram:PurposeCode>Ponovna registracija</ram:PurposeCode>
    <ram:Information>----</ram:Information>
    <ram:AgentBAParty>
      <ram:Name>MUP</ram:Name>
    </ram:AgentBAParty>
  </documentsram:DocumentRVRequestDocument>
  <documentsram:VehicleRVVehicle>
    <ram:BodyTypeCode>Osobno</ram:BodyTypeCode>
    <ram:VINID>KLASDF8988314</ram:VINID>
    <ram:ApplicableRVRequestProduct>
      <ram:BrandName>Mercedes</ram:BrandName>
      <ram:TypeCode>300SLK</ram:TypeCode>
    </ram:ApplicableRVRequestProduct>
    <ram:ActualRVRequestRegistration>
      <ram:RegistrationNumberID>4123-A-737</ram:RegistrationNumberID>
    </ram:ActualRVRequestRegistration>
  </documentsram:VehicleRVVehicle>
</documentsram:RVRequest>
</ram:RegistrationCertificateNumberID>5098903534</ram:RegistrationCertificateNumberID>
```



```
<ram:CertificateOfTitleNumberID>34577777</ram:CertificateOfTitleNumberID>
  <ram:StickerNumberID>345346767</ram:StickerNumberID>
  </ram:ActualRVRequestRegistration>
  <ram:FirstActualRVRequestRegistration>
    <ram:RecordedDate>2012-12-04</ram:RecordedDate>
    <ram:RegistrationNumberID>4123-A-737</ram:RegistrationNumberID>

  <ram:LocationCountrySubDivisionID>Sarajevo</ram:LocationCountrySubDivisionID>
  </ram:FirstActualRVRequestRegistration>
  <ram:InstalledRVEngine>
    <ram:SerialNumberID>123LLF99AA</ram:SerialNumberID>
  </ram:InstalledRVEngine>
</documentsram:VehicleRVVehicle>
<documentsram:OwnerBAParty>
  <ram:TypeCode>Fizička</ram:TypeCode>
  <ram:SpecifiedBAPerson>
    <ram:JMBID>988785685776</ram:JMBID>
    <ram:GivenName>Azra</ram:GivenName>
    <ram:FamilyName>Kovačević</ram:FamilyName>
    <ram:ResidenceAddress>
      <ram:ID>Mlini 10 Sarajevo</ram:ID>
      <ram:BuildingNumber>10</ram:BuildingNumber>
      <ram:StreetName>Mlini</ram:StreetName>
      <ram:CityName>Sarajevo</ram:CityName>
      <ram:MunicipalityCountrySubDivisionName>Novo
Sarajevo</ram:MunicipalityCountrySubDivisionName>
    </ram:ResidenceAddress>
  </ram:SpecifiedBAPerson>
</documentsram:OwnerBAParty>
<documentsram:HolderBAParty>
  <ram:TypeCode>Fizička</ram:TypeCode>
  <ram:RoleCode>Vlasnik</ram:RoleCode>
  <ram:SpecifiedBAPerson>
    <ram:JMBID>988785685776</ram:JMBID>
    <ram:GivenName>Azra</ram:GivenName>
    <ram:FamilyName>Kovačević</ram:FamilyName>
    <ram:ResidenceAddress>
      <ram:BuildingNumber>10</ram:BuildingNumber>
      <ram:StreetName>Mlini</ram:StreetName>
      <ram:CityName>Sarajevo</ram:CityName>
      <ram:MunicipalityCountrySubDivisionName>Novo
Sarajevo</ram:MunicipalityCountrySubDivisionName>
    </ram:ResidenceAddress>
  </ram:SpecifiedBAPerson>
</documentsram:HolderBAParty>
<documentsram:DocumentRVRequestInsuranceDocument>
  <ram:InsuranceID>82370489234789</ram:InsuranceID>
  <ram:InternationalInsuranceID>237089412378904</ram:InternationalInsuranceID>
  <ram:InsuranceAgentBAParty>
    <ram:ID>TRIGLAV</ram:ID>
  </ram:InsuranceAgentBAParty>
  <ram:InternationalInsuranceAgentBAParty>
    <ram:ID>TRIGLAV</ram:ID>
  </ram:InternationalInsuranceAgentBAParty>
</documentsram:DocumentRVRequestInsuranceDocument>
</documentsram:RVRequest>
```



## Izvod iz Matične knjige rođenih

```
<?xml version="1.0" encoding="UTF-8"?>
<!--Sample XML file generated by XMLSpy v2009 (http://www.altova.com)-->
<documentsram:MKRExcerptBirth
xsi:schemaLocation="urn:ReusableAggregateBusinessInformationEntity:1 MKRExcerptBirth.xsd"
xmlns:xsi="http://www.w3.org/2001/XMLSchema-instance"
xmlns:documentsram="urn:ReusableAggregateBusinessInformationEntity:1"
xmlns:ram="urn:un:unece:uncefact:data:standard:ReusableAggregateBusinessInformationEntity:7">
  <documentsram:DocumentMKRDocument>
    <ram:ID>08/13-2-4422/12</ram:ID>
    <ram:IssueDateTime>2010-01-09T00:00:00</ram:IssueDateTime>
    <ram:IncludedMKRNote>
      <ram:Content> / / </ram:Content>
    </ram:IncludedMKRNote>
    <ram:IssuerBAParty>
      <ram:SpecifiedBAPerson>
        <ram:GivenName>Senada</ram:GivenName>
        <ram:FamilyName>Konaković</ram:FamilyName>
      </ram:SpecifiedBAPerson>
    </ram:IssuerBAParty>
    <ram:IssueMKRLocation>
      <ram:Name>Sarajevo</ram:Name>
    </ram:IssueMKRLocation>
    <ram:ReferenceMKRDocument>
      <ram:ID>2994</ram:ID>
      <ram:IssueDateTime>1975-01-14T00:00:00</ram:IssueDateTime>
    </ram:ReferenceMKRDocument>
  </documentsram:DocumentMKRDocument>
  <documentsram:PersonMKRPerson>
    <ram:JMBID>2004975175009</ram:JMBID>
    <ram:GivenName>Malešić</ram:GivenName>
    <ram:FamilyName>Maja</ram:FamilyName>
    <ram:GenderCode>Ženski</ram:GenderCode>
    <ram:BirthDateTime>1975-04-20T00:15:00</ram:BirthDateTime>
    <ram:BirthJurisdictionCountrySubDivisionID>Sarajevo
Centar</ram:BirthJurisdictionCountrySubDivisionID>
    <ram:BirthCountryID>BiH</ram:BirthCountryID>
    <ram:BirthplaceName>Sarajevo</ram:BirthplaceName>
    <ram:CitizenshipNationalityRequestCountry>
      <ram:Name>////</ram:Name>
    </ram:CitizenshipNationalityRequestCountry>
    <ram:FatherFiliationBAPerson>
      <ram:GivenName>Marijan</ram:GivenName>
      <ram:FamilyName>Malešić</ram:FamilyName>
      <ram:ResidenceAddress>
        <ram:CityName>Sarajevo</ram:CityName>
      </ram:ResidenceAddress>
    </ram:FatherFiliationBAPerson>
    <ram:MotherFiliationBAPerson>
      <ram:GivenName>Miroslava</ram:GivenName>
      <ram:FamilyName>dj. Miličević</ram:FamilyName>
      <ram:ResidenceAddress>
        <ram:CityName>Sarajevo</ram:CityName>
      </ram:ResidenceAddress>
  </documentsram:PersonMKRPerson>
</documentsram:MKRExcerptBirth>
```





```
</ram:MotherFiliationBAPerson>  
</documentsram:PersonMKRPerson>  
</documentsram:MKRExcerptBirth>
```

## Izvod iz Matične knjige umrlih

```
<?xml version="1.0" encoding="UTF-8"?>  
<!--Sample XML file generated by XMLSpy v2009 (http://www.altova.com)-->  
<documentsram:MKRExcerptDeath  
  xsi:schemaLocation="urn:ReusableAggregateBusinessInformationEntity:1 MKRExcerptDeath.xsd"  
  xmlns:xsi="http://www.w3.org/2001/XMLSchema-instance"  
  xmlns:documentsram="urn:ReusableAggregateBusinessInformationEntity:1"  
  xmlns:ram="urn:un:uncece:uncefact:data:standard:ReusableAggregateBusinessInformationEntity:7">  
  <documentsram:DocumentMKRDocument>  
    <ram:ID>08/13-5-3043/12</ram:ID>  
    <ram:IssueDateTime>2012-01-06T00:00:00</ram:IssueDateTime>  
    <ram:IncludedMKRNote>  
      <ram:Subject>///</ram:Subject>  
    </ram:IncludedMKRNote>  
    <ram:IssuerBAParty>  
      <ram:SpecifiedBAPerson>  
        <ram:GivenName>Vahida</ram:GivenName>  
        <ram:FamilyName>Omerović</ram:FamilyName>  
      </ram:SpecifiedBAPerson>  
    </ram:IssuerBAParty>  
    <ram:ReferenceMKRDocument>  
      <ram:ID>36</ram:ID>  
      <ram:IssueDateTime>2012-03-27T00:00:00</ram:IssueDateTime>  
    </ram:ReferenceMKRDocument>  
  </documentsram:DocumentMKRDocument>  
  <documentsram:PersonMKRPerson>  
    <ram:JMBID>2810941170012</ram:JMBID>  
    <ram:GivenName>Marijan</ram:GivenName>  
    <ram:FamilyName>Malešić</ram:FamilyName>  
    <ram:MaritalStatusCode>oženjen</ram:MaritalStatusCode>  
    <ram:GenderCode>muški</ram:GenderCode>  
    <ram:BirthDateTime>1941-10-28T00:00:00</ram:BirthDateTime>  
    <ram:BirthJurisdictionCountrySubDivisionID>Hrasno, Novo  
Sarajevo</ram:BirthJurisdictionCountrySubDivisionID>  
    <ram:BirthplaceName>Sarajevo</ram:BirthplaceName>  
    <ram:ResidenceAddress>  
      <ram:BuildingNumber/>  
      <ram:StreetName>Centar</ram:StreetName>  
      <ram:CityName>Sarajevo</ram:CityName>  
    </ram:ResidenceAddress>  
    <ram:CitizenshipNationalityRequestCountry>  
      <ram:Name>Bosna i Hercegovina</ram:Name>  
    </ram:CitizenshipNationalityRequestCountry>  
    <ram:FatherFiliationBAPerson>  
      <ram:GivenName>Anto</ram:GivenName>  
      <ram:FamilyName>Malešić</ram:FamilyName>  
    </ram:FatherFiliationBAPerson>  
    <ram:MotherFiliationBAPerson>  
      <ram:GivenName>Karolina</ram:GivenName>  
      <ram:FamilyName>Jurišić</ram:FamilyName>
```



```
</ram:MotherFiliationBAPerson>
<ram:FiliationBAPerson>
  <ram:GivenName>Miroslava</ram:GivenName>
  <ram:FamilyName>Malešić</ram:FamilyName>
  <ram:MaidenName>Miličević</ram:MaidenName>
</ram:FiliationBAPerson>
<ram:DeathSpecifiedMKREvent>
  <ram:OccurrenceDateTime>2011-12-
31T09:00:00</ram:OccurrenceDateTime>
  <ram:OccurrenceMKRLocation>
    <ram:Name>Centar Sarajevo</ram:Name>
  </ram:OccurrenceMKRLocation>
  <ram:RelatedMKRLocation>
    <ram:Name>Sarajevo, Bare</ram:Name>
  </ram:RelatedMKRLocation>
</ram:DeathSpecifiedMKREvent>
</documentsram:PersonMKRPerson>
</documentsram:MKRExcerptDeath>
```

## Uvjerenje o državljanstvu

```
<?xml version="1.0" encoding="UTF-8"?>
<!--Sample XML file generated by XMLSpy v2009 (http://www.altova.com)-->
<userram:CitizenshipCertificate
xsi:schemaLocation="urn:ReusableAggregateBusinessInformationEntity:1 CitizenshipCertificate.xsd"
xmlns:xsi="http://www.w3.org/2001/XMLSchema-instance"
xmlns:userram="urn:ReusableAggregateBusinessInformationEntity:1"
xmlns:ram="urn:un:unece:uncefact:data:standard:ReusableAggregateBusinessInformationEntity:7">
  <userram:DocumentCitizenshipCertificateDocument>
    <ram:BrojID>08/13-5-35613/12</ram:BrojID>
    <ram:IssueDateTime>2012-02-27T00:00:00</ram:IssueDateTime>
    <ram:IssuerBAParty>
      <ram:SpecifiedBAPerson>
        <ram:GivenName>Vahida</ram:GivenName>
        <ram:FamilyName>Omerović</ram:FamilyName>
      </ram:SpecifiedBAPerson>
    </ram:IssuerBAParty>
  </userram:DocumentCitizenshipCertificateDocument>
  <userram:PersonCitizenshipCertificatePerson>
    <ram:JMBID>2004975175009</ram:JMBID>
    <ram:GivenName>Maja</ram:GivenName>
    <ram:FamilyName>Malešić</ram:FamilyName>
    <ram:BirthDateTime>1975-04-20T00:00:00</ram:BirthDateTime>

    <ram:BirthJurisdictionCountrySubDivisionID>Centar</ram:BirthJurisdictionCountrySubDivision
ID>
    <ram:BirthCountryID>Bosna i Hercegovina</ram:BirthCountryID>
    <ram:BirthplaceName>Sarajevo</ram:BirthplaceName>
    <ram:ParentFiliationRelatedPerson>
      <ram:GivenName>Marijan</ram:GivenName>
    </ram:ParentFiliationRelatedPerson>
  </userram:PersonCitizenshipCertificatePerson>
</userram:CitizenshipCertificate>
```



## Pasoš

```
<?xml version="1.0" encoding="UTF-8"?>
<!--Sample XML file generated by XMLSpy v2009 (http://www.altova.com)-->
<documentsram:PassportRequest
xsi:schemaLocation="urn:ReusableAggregateBusinessInformationEntity:1 Passport.xsd"
xmlns:xsi="http://www.w3.org/2001/XMLSchema-instance"
xmlns:documentsram="urn:ReusableAggregateBusinessInformationEntity:1"
xmlns:ram="urn:un:unece:uncefact:data:standard:ReusableAggregateBusinessInformationEntity:7">
  <documentsram:DocumentPassportRequestDocument>
    <ram:NumberID>A000B418</ram:NumberID>
    <ram:SerialID>8BIH8506117F1410273</ram:SerialID>
    <ram:IssueDateTime>2010-09-18T00:00:00</ram:IssueDateTime>
    <ram:PurposeCode>P</ram:PurposeCode>
    <ram:IssuerBAParty>
      <ram:Name>BIH</ram:Name>
    </ram:IssuerBAParty>
    <ram:PhotoAttachedPhotoBinaryFile>
      <ram:IncludedBinaryObject/>
    </ram:PhotoAttachedPhotoBinaryFile>
    <ram:EffectiveBAPeriod>
      <ram:EndDateDateTime>2012-09-10T00:00:00</ram:EndDateDateTime>
    </ram:EffectiveBAPeriod>
  </documentsram:DocumentPassportRequestDocument>
  <documentsram:PersonPassportRequestPerson>
    <ram:JMBID>12345677882343</ram:JMBID>
    <ram:GivenName>Azra-Marina</ram:GivenName>
    <ram:FamilyName>Kovačević</ram:FamilyName>
    <ram:GenderCode>F</ram:GenderCode>
    <ram:BirthDateTime>1975-09-10T00:00:00</ram:BirthDateTime>
    <ram:BirthplaceName>UTOPIA</ram:BirthplaceName>
  </documentsram:PersonPassportRequestPerson>
</documentsram:PassportRequest>
```

## Izvod iz evidencije JMB

```
<?xml version="1.0" encoding="UTF-8"?>
<!--Sample XML file generated by XMLSpy v2009 (http://www.altova.com)-->
<documentsram:JMBExcerpt
xsi:schemaLocation="urn:ReusableAggregateBusinessInformationEntity:1 JMBExcerpt.xsd"
xmlns:xsi="http://www.w3.org/2001/XMLSchema-instance"
xmlns:documentsram="urn:ReusableAggregateBusinessInformationEntity:1"
xmlns:ram="urn:un:unece:uncefact:data:standard:ReusableAggregateBusinessInformationEntity:7">
  <documentsram:DocumentJMBExcerptDocument>
    <ram:ID>1231/123--123</ram:ID>
    <ram:IssueDateTime>2012-09-18T00:00:00</ram:IssueDateTime>
    <ram:ReferenceJMBRequestMKRDocument>
      <ram:ID>12312</ram:ID>
      <ram:CreationDateTime>2012-09-17T00:00:00</ram:CreationDateTime>
    </ram:ReferenceJMBRequestMKRDocument>
    <ram:AgentBAParty>
      <ram:Name>MB</ram:Name>
    </ram:AgentBAParty>
  </documentsram:DocumentJMBExcerptDocument>
</documentsram:PersonJMBRequestPerson>
```



```
<ram:JMBID>12898666</ram:JMBID>
<ram:GivenName languageCode="en-us">Maja</ram:GivenName>
<ram:FamilyName languageCode="en-us">Malešić</ram:FamilyName>
<ram:GenderCode listID="token" listSchemeURI="http://www.altova.com"
listVersionID="token" listName="String" name="String" listURI="http://www.altova.com"
listAgencyName="String" listAgencyID="1" languageCode="en-us">Ženski</ram:GenderCode>
<ram:ChangeGenderCode listID="token" listSchemeURI="http://www.altova.com"
listVersionID="token" listName="String" name="String" listURI="http://www.altova.com"
listAgencyName="String" listAgencyID="1" languageCode="en-us">token</ram:ChangeGenderCode>
<ram:BirthDateTime>2001-12-17T09:30:47Z</ram:BirthDateTime>
<ram:MunicipalityBirthJurisdictionCountrySubDivisionID>NOVO
SARAJEVO</ram:MunicipalityBirthJurisdictionCountrySubDivisionID>
<ram:BirthCountryID>BIH</ram:BirthCountryID>
<ram:BirthplaceName>SARAJEVO</ram:BirthplaceName>
</documentsram:PersonJMBRequestPerson>
</documentsram:JMBExcerpt>
```

### Izvod iz evidencije LK

```
<?xml version="1.0" encoding="UTF-8"?>
<!--Sample XML file generated by XMLSpy v2009 (http://www.altova.com)-->
<documentsram:LKExcerpt xsi:schemaLocation="urn:ReusableAggregateBusinessInformationEntity:1
LKExcerpt.xsd" xmlns:xsi="http://www.w3.org/2001/XMLSchema-instance"
xmlns:documentsram="urn:ReusableAggregateBusinessInformationEntity:1"
xmlns:ram="urn:un:uncece:uncefact:data:standard:ReusableAggregateBusinessInformationEntity:7">
  <documentsram:DocumentLKExcerptDocument>
    <ram:ID/>
    <ram:IssueDateTime>2001-02-16T00:00:00</ram:IssueDateTime>
    <ram:Remarks/>
    <ram:IssuerBAParty>
      <ram:Name>SJB Centar Sarajevo</ram:Name>
    </ram:IssuerBAParty>
    <ram:AcceptableLKPeriod>
      <ram:EndDateTime>2006-02-14T00:00:00</ram:EndDateTime>
    </ram:AcceptableLKPeriod>
  </documentsram:DocumentLKExcerptDocument>
  <documentsram:PersonLKRequestPerson>
    <ram:JMBID>1605975175011</ram:JMBID>
    <ram:GivenName>Vesna</ram:GivenName>
    <ram:FamilyName>Vuković</ram:FamilyName>
    <ram:GenderCode>Ž/F</ram:GenderCode>
    <ram:BirthDateTime>1975-05-16T00:00:00</ram:BirthDateTime>
    <ram:BirthplaceName>SARAJEVO</ram:BirthplaceName>
    <ram:ResidenceLKRequestAddress>
      <ram:PrebivalisteCountryIdentificationBACountrySubDivision>
        <ram:Name>Olimpijska 11, Sarajevo</ram:Name>
      </ram:PrebivalisteCountryIdentificationBACountrySubDivision>
    </ram:ResidenceLKRequestAddress>
    <ram:NationalityRequestCountry>
      <ram:Name>BiH</ram:Name>
    </ram:NationalityRequestCountry>
  </documentsram:PersonLKRequestPerson>
</documentsram:LKExcerpt>
```



### Izvod iz evidencije prebivališta/boravišta

```
<?xml version="1.0" encoding="UTF-8"?>
<!--Sample XML file generated by XMLSpy v2009 (http://www.altova.com)-->
<userram:ResidenceExcerpt
xsi:schemaLocation="urn:ReusableAggregateBusinessInformationEntity:1 ResidenceExcerpt.xsd"
xmlns:xsi="http://www.w3.org/2001/XMLSchema-instance"
xmlns:userram="urn:ReusableAggregateBusinessInformationEntity:1"
xmlns:ram="urn:un:unece:uncefact:data:standard:ReusableAggregateBusinessInformationEntity:7">
  <userram:DocumentResidenceExcerptDocument>
    <ram:ID>PB3-190077-12</ram:ID>
    <ram:IssueDateTime>2012-09-26T00:00:00</ram:IssueDateTime>
    <ram:IssuerBAParty>
      <ram:Name>MUP KS</ram:Name>
      <ram:SpecifiedResidenceAddress>
        <ram:MunicipalityCountrySubDivisionName>NOVO
SARAJEVO</ram:MunicipalityCountrySubDivisionName>
      </ram:SpecifiedResidenceAddress>
    </ram:IssuerBAParty>
  </userram:DocumentResidenceExcerptDocument>
  <userram:PersonResidenceExcerptPerson>
    <ram:JMBID>2103983178105</ram:JMBID>
    <ram:GivenName>Elmira</ram:GivenName>
    <ram:FamilyName>Kršo</ram:FamilyName>
    <ram:GenderCode>ŽENSKI</ram:GenderCode>
    <ram:BirthDateTime>1983-03-21T00:00:00</ram:BirthDateTime>
    <ram:PreviousName/>
    <ram:BirthJurisdictionCountrySubDivisionID>SARAJEVO
CENTAR</ram:BirthJurisdictionCountrySubDivisionID>
    <ram:BirthplaceName>SARAJEVO</ram:BirthplaceName>
    <ram:ResidenceAddress>
      <ram:BuildingNumber>161</ram:BuildingNumber>
      <ram:FloorIdentification/>
      <ram:StreetName>NOVOPAZARSKA</ram:StreetName>
      <ram:CityName>SARAJEVO</ram:CityName>
      <ram:MunicipalityCountrySubDivisionName>NOVO
SARAJEVO</ram:MunicipalityCountrySubDivisionName>
      <ram:CantonCountrySubDivisionID>KANTON
SARAJEVO</ram:CantonCountrySubDivisionID>
      <ram:EntityCountrySubDivisionID>FEDERACIJA BOSNE I
HERCEGOVINE</ram:EntityCountrySubDivisionID>
      <ram>StatusDescription>STALNO</ram>StatusDescription>
    </ram:ResidenceAddress>
    <ram:ResidenceExcerptNationalityRequestCountry>
      <ram:Name>BOSNA I HERCEGOVINA</ram:Name>
    </ram:ResidenceExcerptNationalityRequestCountry>
  </userram:PersonResidenceExcerptPerson>
</userram:ResidenceExcerpt>
```

### Izvod iz evidencije vozila

```
<?xml version="1.0" encoding="UTF-8"?>
<!--Sample XML file generated by XMLSpy v2009 (http://www.altova.com)-->
<documentsram:VehicleExcerpt
xsi:schemaLocation="urn:ReusableAggregateBusinessInformationEntity:1 VehicleExcerpt.xsd"
```



```
xmlns:xsi="http://www.w3.org/2001/XMLSchema-instance"
xmlns:documentsram="urn:ReusableAggregateBusinessInformationEntity:1"
xmlns:ram="urn:un:unece:uncefact:data:standard:ReusableAggregateBusinessInformationEntity:7">
  <documentsram:DocumentRVExcerptDocument>
    <ram:Information>--</ram:Information>
    <ram:AgentBAParty>
      <ram:Name>MP</ram:Name>
    </ram:AgentBAParty>
  </documentsram:DocumentRVExcerptDocument>
  <documentsram:VehicleRVVehicle>
    <ram:BodyTypeCode>Limuzina</ram:BodyTypeCode>
    <ram:VINID>2339964442</ram:VINID>
    <ram:GrossWeightMeasure>2000</ram:GrossWeightMeasure>
    <ram:TareWeightMeasure>1500</ram:TareWeightMeasure>
    <ram:MaximumLoadMeasure>500</ram:MaximumLoadMeasure>
    <ram:SeatQuantity>5</ram:SeatQuantity>
    <ram:ApplicableRVRequestProduct>
      <ram:TypeApprovalID>89042342</ram:TypeApprovalID>
      <ram:RegistrationNumberID>1455-A-745</ram:RegistrationNumberID>
      <ram:BrandName></ram:BrandName>
      <ram:ModelName>200D</ram:ModelName>
      <ram:Description>Osobno vozilo</ram:Description>
      <ram:TypeCode>Osobno</ram:TypeCode>
      <ram:PlacesLyingMeasurementCode>-
</ram:PlacesLyingMeasurementCode>
      <ram:PlacesStandingMeasurementCode>-
</ram:PlacesStandingMeasurementCode>
      <ram:IndividualRVProductInstance>
        <ram:ProductionBAEvent>
          <ram:OccurrenceDateTime>2012-10-
15T00:00:00</ram:OccurrenceDateTime>
        </ram:ProductionBAEvent>
      </ram:IndividualRVProductInstance>
    </ram:ApplicableRVRequestProduct>
    <ram:ActualRVRequestRegistration>
      <ram:RegistrationCertificateNumberID>4566932322</ram:RegistrationCertificateNumberID>
      <ram:LocationCountrySubDivisionID>Sarajevo</ram:LocationCountrySubDivisionID>
      <ram:ValidityBAPeriod>
        <ram:EndDateTime>2012-10-31T00:00:00</ram:EndDateTime>
      </ram:ValidityBAPeriod>
    </ram:ActualRVRequestRegistration>
    <ram:FirstActualRVRequestRegistration>
      <ram:RegistrationNumberID>1455-A-746</ram:RegistrationNumberID>
    </ram:FirstActualRVRequestRegistration>
    <ram:LocationCountrySubDivisionID>Sarajevo</ram:LocationCountrySubDivisionID>
    <ram:ValidityBAPeriod>
      <ram:StartDateTime>2012-09-24T00:00:00</ram:StartDateTime>
    </ram:ValidityBAPeriod>
    </ram:FirstActualRVRequestRegistration>
    <ram:InstalledRVEngine>
      <ram:TypeCode>DI</ram:TypeCode>
      <ram:ECOTypeCode>--</ram:ECOTypeCode>
      <ram:CatalystTypeCode>--</ram:CatalystTypeCode>
      <ram:SerialNumberID>1395623444</ram:SerialNumberID>
      <ram:FuelTypeCode>Dizel</ram:FuelTypeCode>
    </ram:InstalledRVEngine>
  </ram:ActualRVRequestRegistration>
</documentsram:VehicleRVVehicle>
</documentsram:VehicleRVVehicle>
```



```
<ram:PowerMeasure>90</ram:PowerMeasure>
<ram:WeightRatioPowerMeasure>10</ram:WeightRatioPowerMeasure>
<ram:CubicCapacityMeasure>1400</ram:CubicCapacityMeasure>
</ram:InstalledRVEngine>
<ram:SpecifiedRVColour>
  <ram:ActualColourCode>Red</ram:ActualColourCode>
</ram:SpecifiedRVColour>
</documentsram:VehicleRVVehicle>
<documentsram:HolderBAParty>
  <ram:TypeCode>Fizička</ram:TypeCode>
  <ram:RoleCode>Vlasnik</ram:RoleCode>
  <ram:SpecifiedBAPerson>
    <ram:JMBID>1295523336</ram:JMBID>
    <ram:GivenName>Mirko</ram:GivenName>
    <ram:FamilyName>Mirić</ram:FamilyName>
    <ram:ResidenceAddress>
      <ram:BuildingNumber>10</ram:BuildingNumber>
      <ram:StreetName>Mlini</ram:StreetName>
      <ram:CityName>Sarajevo</ram:CityName>
      <ram:MunicipalityCountrySubDivisionName>Novo
Sarajevo</ram:MunicipalityCountrySubDivisionName>
    </ram:ResidenceAddress>
  </ram:SpecifiedBAPerson>
</documentsram:HolderBAParty>
<documentsram:DocumentRVRequestInsuranceDocument/>
</documentsram:VehicleExcerpt>
```

## Potvrda o plaćenim porezima i doprinosima

```
<?xml version="1.0" encoding="UTF-8"?>
<!--Sample XML file generated by XMLSpy v2009 (http://www.altova.com)-->
<documentsram:Clearance xsi:schemaLocation="urn:ReusableAggregateBusinessInformationEntity:1
Clearance.xsd" xmlns:xsi="http://www.w3.org/2001/XMLSchema-instance"
xmlns:documentsram="urn:ReusableAggregateBusinessInformationEntity:1"
xmlns:ram="urn:un:unece:uncefact:data:standard:ReusableAggregateBusinessInformationEntity:7">
  <documentsram:DocumentClearanceDocument>
    <ram:ID>234/7457-7454</ram:ID>
    <ram:IssueDateTime>2012-10-01T00:00:00</ram:IssueDateTime>
    <ram:PurposeCode>UVJERENJE o ...</ram:PurposeCode>
    <ram:IssuerClearanceParty>
      <ram:Name>Partija koja potvrđuje</ram:Name>
      <ram:CountryID>BIH</ram:CountryID>
    </ram:IssuerClearanceParty>
  </documentsram:DocumentClearanceDocument>
  <documentsram:SpecifiedPartyClearanceParty>
    <ram:Name>Tvrtka</ram:Name>
    <ram:SpecifiedResidenceAddress>
      <ram:BuildingNumber>Broj</ram:BuildingNumber>
      <ram:StreetName>Ulica</ram:StreetName>
      <ram:CityName>Grad</ram:CityName>
    </ram:SpecifiedResidenceAddress>
  </documentsram:SpecifiedPartyClearanceParty>
</documentsram:Clearance>
```



## Zdravstveno osiguranje prijava/odjava

```
<?xml version="1.0" encoding="UTF-8"?>
<!--Sample XML file generated by XMLSpy v2009 (http://www.altova.com)-->
<documentsram:ZDRegistration
xsi:schemaLocation="urn:ReusableAggregateBusinessInformationEntity:1 ZDRegistration.xsd"
xmlns:xsi="http://www.w3.org/2001/XMLSchema-instance"
xmlns:documentsram="urn:ReusableAggregateBusinessInformationEntity:1"
xmlns:ram="urn:un:uncece:uncefact:data:standard:ReusableAggregateBusinessInformationEntity:7">
  <documentsram:DocumentZDRegistrationDocument>
    <ram:AcceptanceDateTime>2012-10-02T00:00:00</ram:AcceptanceDateTime>
    <ram:PurposeCode>Prijava - Porodica</ram:PurposeCode>
    <ram:AgentBAParty>
      <ram:Name>ZD ustanova</ram:Name>
    </ram:AgentBAParty>
  </documentsram:DocumentZDRegistrationDocument>
  <documentsram:HolderZDRegistrationPerson>
    <ram:JMBID>123123</ram:JMBID>
    <ram:GivenName/>
    <ram:FamilyName>Mario Marić</ram:FamilyName>
    <ram:ResidenceAddress>
      <ram:MunicipalityCountrySubDivisionName>Općina
prebiv</ram:MunicipalityCountrySubDivisionName>
      <ram:CountryIdentificationBACountrySubDivision/>
    </ram:ResidenceAddress>
  </documentsram:HolderZDRegistrationPerson>
  <documentsram:BeneficiaryZDRegistrationPerson>
    <ram:JMBID>2813</ram:JMBID>
    <ram:GivenName>druigi</ram:GivenName>
    <ram:FamilyName>aaa</ram:FamilyName>
    <ram:GenderCode>f</ram:GenderCode>
    <ram:BirthDateTime>2012-10-01T00:00:00</ram:BirthDateTime>
    <ram:Role>kćer</ram:Role>
    <ram:ResidenceAddress>
      <ram:ID/>
      <ram:BuildingNumber>23</ram:BuildingNumber>
      <ram:StreetName>Ulica</ram:StreetName>
      <ram:CityName>Sarajevo</ram:CityName>
    </ram:ResidenceAddress>
  </documentsram:BeneficiaryZDRegistrationPerson>
  <documentsram:BeneficiaryZDRegistrationPerson>
    <ram:JMBID>345345</ram:JMBID>
    <ram:GivenName>treći</ram:GivenName>
    <ram:FamilyName>bbb</ram:FamilyName>
    <ram:GenderCode>m</ram:GenderCode>
    <ram:BirthDateTime>2012-10-01T00:00:00</ram:BirthDateTime>
    <ram:Role>sin</ram:Role>
    <ram:ResidenceAddress>
      <ram:ID/>
      <ram:BuildingNumber>8</ram:BuildingNumber>
      <ram:StreetName>Ulica</ram:StreetName>
      <ram:CityName>Sarajevo</ram:CityName>
    </ram:ResidenceAddress>
  </documentsram:BeneficiaryZDRegistrationPerson>
</documentsram:RegistrationZDRegistration>
```





```
<ram:CountrySubDivisionID schemeName="Općina prij"/>
<ram:ValidityBAPeriod>
  <ram:StartDateTime>2012-10-15T00:00:00</ram:StartDateTime>
</ram:ValidityBAPeriod>
</documentsram:RegistrationZDRRegistration>
</documentsram:ZDRRegistration>
```

## Penziono osiguranje prijava/odjava

```
<?xml version="1.0" encoding="UTF-8"?>
<!--Sample XML file generated by XMLSpy v2009 (http://www.altova.com)-->
<documentsram:MORegistration
xsi:schemaLocation="urn:ReusableAggregateBusinessInformationEntity:1 MORegistration.xsd"
xmlns:xsi="http://www.w3.org/2001/XMLSchema-instance"
xmlns:documentsram="urn:ReusableAggregateBusinessInformationEntity:1"
xmlns:ram="urn:un:unece:uncefact:data:standard:ReusableAggregateBusinessInformationEntity:7">
  <documentsram:DocumentMORegistrationDocument>
    <ram:ID>5343</ram:ID>
    <ram:BrojID>2342366</ram:BrojID>
    <ram:SubmissionDateTime>2012-09-19T00:00:00</ram:SubmissionDateTime>
    <ram:AcceptanceDateTime>2012-09-28T00:00:00</ram:AcceptanceDateTime>
    <ram:AcceptedByInformation>primaoc</ram:AcceptedByInformation>
    <ram:EnteredByInformation>unio prezime</ram:EnteredByInformation>
    <ram:SubmissionLocationInformation>Mjesto</ram:SubmissionLocationInformation>
  </documentsram:DocumentMORegistrationDocument>
  <documentsram:RegistrationMORegistration>
    <ram:ValidityBAPeriod>
      <ram>Description>isteklo</ram>Description>
      <ram:EndTime>2012-09-28T00:00:00</ram:EndTime>
    </ram:ValidityBAPeriod>
  </documentsram:RegistrationMORegistration>
  <documentsram:OrganizationMOOrganization>
    <ram:TaxRegistrationID>2346622343</ram:TaxRegistrationID>
    <ram>Name>Firma</ram>Name>
    <ram>ID>52234234</ram>ID>
    <ram:PostalResidenceAddress>
      <ram:CityName>Mjesto</ram:CityName>
    </ram:PostalResidenceAddress>
  </documentsram:OrganizationMOOrganization>
  <documentsram:PersonMOPerson>
    <ram:JMBID>123123123</ram:JMBID>
    <ram:GivenName>Azra</ram:GivenName>
    <ram:FamilyName>Kovačić</ram:FamilyName>
    <ram:GenderCode>F</ram:GenderCode>
    <ram:BirthDateTime>1975-10-01T00:00:00</ram:BirthDateTime>
    <ram:SpecialDataDescription>-</ram:SpecialDataDescription>
    <ram:OtherRightsDescription>-</ram:OtherRightsDescription>
    <ram:HighestEducationLevelCode>kv</ram:HighestEducationLevelCode>
    <ram:SpecifiedBAOccupation>
      <ram>Description>stolar</ram>Description>
    </ram:SpecifiedBAOccupation>
  </documentsram:PersonMOPerson>
</documentsram:MORegistration>
```



## Nalog za plaćanje

```
<?xml version="1.0" encoding="UTF-8"?>
<!--Sample XML file generated by XMLSpy v2009 (http://www.altova.com)-->
<documentsram:BAPayment
xsi:schemaLocation="urn:ReusableAggregateBusinessInformationEntity:1 BAPayment.xsd"
xmlns:xsi="http://www.w3.org/2001/XMLSchema-instance"
xmlns:documentsram="urn:ReusableAggregateBusinessInformationEntity:1"
xmlns:ram="urn:un:unece:uncefact:data:standard:ReusableAggregateBusinessInformationEntity:7">
  <documentsram:PaymentMeansBAPaymentMeans>
    <ram:PaidAmount>563.21</ram:PaidAmount>
    <ram:Information>Plaćanje primljenog računa</ram:Information>
    <ram:PayerPartyBAFinancialAccount>
      <ram:ID>1123662223</ram:ID>
      <ram:OwnerBAParty>
        <ram:Name>Firma 1</ram:Name>
        <ram:SpecifiedResidenceAddress>
          <ram:PostcodeCode>71000</ram:PostcodeCode>
          <ram:BuildingNumber>10</ram:BuildingNumber>
          <ram:StreetName>Mlini</ram:StreetName>
          <ram:CityName>Sarajevo</ram:CityName>
          <ram:CountryName>BIH</ram:CountryName>
        </ram:SpecifiedResidenceAddress>
      </ram:OwnerBAParty>
    </ram:PayerPartyBAFinancialAccount>
    <ram:PayeePartyBAFinancialAccount>
      <ram:ID>6763332222</ram:ID>
      <ram:OwnerBAParty>
        <ram:Name>Firma 2</ram:Name>
        <ram:SpecifiedResidenceAddress>
          <ram:PostcodeCode>71000</ram:PostcodeCode>
          <ram:BuildingNumber>40</ram:BuildingNumber>
          <ram:StreetName>Mlini</ram:StreetName>
          <ram:CityName>Sarajevo</ram:CityName>
          <ram:CountryName>BIH</ram:CountryName>
        </ram:SpecifiedResidenceAddress>
      </ram:OwnerBAParty>
    </ram:PayeePartyBAFinancialAccount>
    <ram:RelatedBAPayment>
      <ram:PayerPaymentInstructionID>20</ram:PayerPaymentInstructionID>
      <ram:PayerInstructionID>523666-2343</ram:PayerInstructionID>
      <ram:PayeePaymentInstructionID>5</ram:PayeePaymentInstructionID>
      <ram:PayeeInstructionID>23223456-222</ram:PayeeInstructionID>
      <ram:RequestedExecutionDateTime>2012-10-
08T00:00:00</ram:RequestedExecutionDateTime>
      <ram:PriorityCode>5</ram:PriorityCode>
      <ram:ClearingChannelCode>10</ram:ClearingChannelCode>
    </ram:RelatedBAPayment>
  </documentsram:PaymentMeansBAPaymentMeans>
</documentsram:BAPayment>
```



## 6. POPIS PRILOGA

Elementi:

- podatkovni modeli – distribuiše se kao .XLS koji sadrži aktuelni model komponenti za primjenu
  - selekcija komponenti CC libraryja
  - modelirane BIE komponente
  - podatkovni model za odabrane formulare (zahtjev za ličnu kartu, JMB, vozačku dozvolu, ...)
- XSD sheme - .XSD fileovi
  - sheme za BIE komponente
  - sheme za odabrane dokumente
- XSD sheme – ispis dokumentacije modela (.doc format)
  - sheme za BIE komponente
  - sheme kao primjer za odabrane formulare



PROJEKT  
IZRADA I USPOSTAVLJANJE OKVIRA INTEROPERABILNOSTI I  
STANDARDA ZA RAZMJENU PODATAKA  
**INICIJALNI RJEČNIK PODATAKA**

Oznaka:  
PARCO-IFBIH

Page: 124 of 124